

MISSONI

HOME COLLECTION

ARREDO, ILLUMINAZIONE E TESSUTI
FURNITURE, LIGHTING AND FABRICS

2022

MISSONI

HOME COLLECTION

LIVING ROOM

10 ADAR DIVANO



24 TIAMAT



38 VIRGOLA



50 SPOOL CEDAR



12 GRAVITÀ



26 TOP 4 BIG



40 JALAMAR INDOOR



52 HARRY GLASS INDOOR



14 INNTIL
DIVANO E POLTRONA



28 TEKTONIK



42 ART GLASS



54 LONG / WIDE



16 INNTIL
DIVANO MODULARE



30 CORDULA
POLTRONA ROTONDA



44 CORDULA CUOIO
TAVOLINO ROTONDO



56 LOW



18 NAP INDOOR



32 CORDULA
POLTRONCINA E POGGIPIEDI



46 CORDULA CUOIO
TAVOLINI QUADRATI



58 GEMMA



20 MISTER DIVANO NEW



34 GRANDMA



48 HOLLY ART GLASS



60 PUNTASPILLONE



22 MISTER
DIVANO MODULARE NEW



36 MILADY



DINING ROOM



BEDROOM



OUTDOOR



LIGHTING

114 **BUBBLE KNIT**
LAMPADA DA SOSPENSIONE



116 **BUBBLE KNIT**
LAMPADA DA TERRA



118 **BUBBLE NUDE**
LAMPADA DA SOSPENSIONE



120 **BUBBLE NUDE**
LAMPADA DA TERRA



122 **CORDULA LAMPADA**



124 **DRUM**



126 **DRUM KNIT**



128 **THEA KUTA**



130 **SOPHIE**



132 **SOPHIE KNIT NEW**



FABRICS

136 **ROMA**

162 **INDOOR**

140 **CALABASAS**

194 **OUTDOOR**

144 **BALI**

204 **SHEERS**

148 **COURCHEVEL**

152 **NEW YORK**

158 **MUSTHAVE ICONS**

160 **MUSTHAVE POP**

LIVING
ROOM



ADAR

DIVANO SOFA

Altri prodotti della collezione Adar: pag. 76 Adar letto
Combinabile con i tavolini Harry Glass indoor: pag. 52

Other products from Adar collection: pag.76 Adar bed
Combinable with Harry Glass indoor sidetables: pag. 52



Design e comfort. Moduli geometrici e spaziosi da comporre in divano o da gestire singolarmente. Gli schienali e i braccioli sostenuti dall'intelaiatura di acciaio sono comode forme indipendenti a maxi-cuscino sfilabili dalla base. Rivestimento a scelta tra i pattern dei tessuti d'arredamento Missoni Home Collection. Si consiglia l'opzione di un cuscino poggiatesta per ogni seduta.

Design and comfort. Geometric and spacious modules, to be placed in composition or to be used individually. The comfortable backs and armrests, supported by the steel frame, are independent forms alongside removable maxi-cushions. The upholstery can be chosen from furnishing fabrics in the Missoni Home Collection. For comfort, a back cushion for each module is recommended.

ELEMENTO CENTRALE
CENTRAL SOFA UNIT

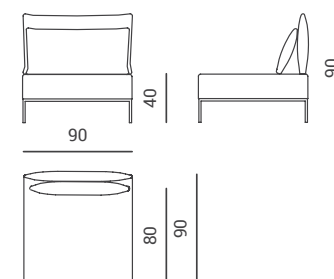

ELEMENTO FINALE CON BRACCIOLO DX O SX
END SOFA UNIT WITH RIGHT OR LEFT ARM

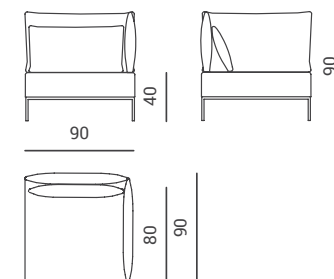

ELEMENTO POUF
POUF UNIT

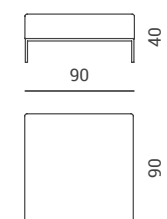

CUSCINO POGGIARENI
BACK CUSHION

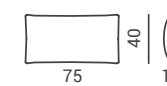

ADAR

DIVANO SOFA

design by
MISSONI STUDIO
Made in Italy

Materiali - Materials

Base: telaio in acciaio verniciato a polvere in colore Charcoal

Piedini: in materiale plastico e lana ad alta densità, antiscivolo e antigraffio

Struttura: multistrato con sospensione su cinghie elastiche

Imbottitura: poliuretano espanso indeformabile a quote differenziate, rivestito di ovatta in fibra di poliestere

Rivestimento: tessuto sfoderabile, lavabile secondo le indicazioni riportate sull'etichetta

Sistema di aggancio di schienali e braccioli: perni in metallo inseriti a baionetta nelle sedi della base

Sistema di aggancio fra moduli: ad incastro rapido, predisposti in base alla composizione scelta



INDOOR



RIVESTIMENTO SFODERABILE
REMOVABLE COVER

Base: steel frame, powder coated in charcoal colour

Feet: anti-slip and non-scratch plastic and high-density wool

Structure: multilayer with elastic wadding suspension

Padding: non-deformable polyurethane foam, in different densities, covered with polyester fiber wadding

Upholstery: removable Cover: washable according to the instructions on the label

System for attaching backs and armrests: metal pin bayonets inserted in the seat of the base



Modulo Unit	Peso netto Net weight	Peso con imballo Packed weight	Volume imballo Packed volume
Finale End	25 kg	35 kg	0,5 m ³
Centrale Central	21 kg	30 kg	0,5 m ³
Pouf Pouf	15 kg	25 kg	0,5 m ³
Cuscino Cushion	1,5 kg		

Portata massima per modulo Maximum load per module

120 kg

GRAVITÀ

POLTRONA E DIVANO ARMCHAIR AND SOFA



Dettaglio Detail



Sedute a sistema. Progetto uniforme, pluriforme, policromo. Il comfort essenziale e la rotondità lineare sono la caratteristica delle sedute Gravità. L'estrema funzionalità della struttura imbottita consente sviluppi in 4 dimensioni, dalla mini-poltrona al divano 3 posti. Il rivestimento: a scelta tra i tessuti d'arredamento Missoni Home Collection, può allineare o essere fattore distintivo.

Seating range. A uniform design, multiform and polychrome. The hallmarks of the Gravità collection are essential comfort and a linear roundness. The great functionality of the padded structure allows for the development of the range in 4 sizes, from the mini-chair to a 3-seat sofa. The upholstery can be chosen from furnishing fabrics in the Missoni Home Collection, to be a distinctive factor or to align.

GRAVITÀ

POLTRONA E DIVANO ARMCHAIR AND SOFA

design by
BENDIK TORVIN
Made in Italy

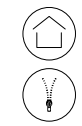

INDOOR



RIVESTIMENTO SFODERABILE
REMOVABLE COVER

Materiali - Materials

Struttura: legno multistrato, sospensione su cinghie elastiche

Piedini: plastica antiscivolo e antigraffio

Imbottitura: poliuretano espanso indeformabile a quote differenziate, rivestito di ovatta in fibra di poliestere

Rivestimento: tessuto sfoderabile, lavabile secondo le indicazioni riportate sull'etichetta

Structure: plywood, elastic webbing suspension

Feet: anti-slip and non-scratch plastic

Padding: non-deformable polyurethane foam with different densities, covered with polyester fiber wadding

Upholstery: removable fabric, washable according to the instructions on the label



MINI POLTRONA MINI ARMCHAIR

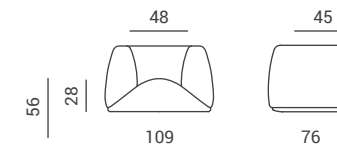

POLTRONA ARMCHAIR

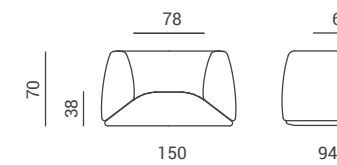

DIVANO 2 POSTI 2P SOFA

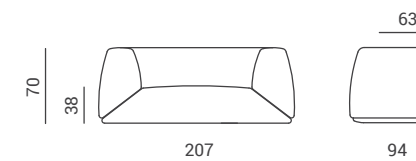

DIVANO 3 POSTI 3P SOFA

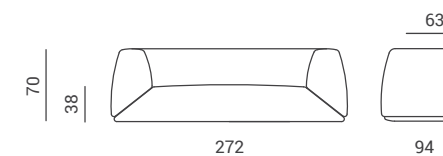

Mini poltrona Mini chair
Peso netto Net weight 25 kg
Peso con imballo Packed weight 30 kg
Volume imballo Packed volume 0,6 m³
Portata massima Maximum load 80 kg

Poltrona Chair
Peso netto Net weight 34 kg
Peso con imballo Packed weight 40 kg
Volume imballo Packed volume 1,5 m³
Portata massima Maximum load 120 kg

Divano 2 posti Sofa 2 seat
Peso netto Net weight 44 kg
Peso con imballo Packed weight 50 kg
Volume imballo Packed volume 2,15 m³
Portata massima Maximum load 240 kg

Divano 3 posti Sofa 3 seat
Peso netto Net weight 54 kg
Peso con imballo Packed weight 60 kg
Volume imballo Packed volume 2,8 m³
Portata massima Maximum load 300 kg

INNTIL

DIVANO E POLTRONA SOFA AND ARMCHAIR

Altri prodotti della collezione Inntil: pag. 16 - 78
Other products from Inntil collection: pag. 16 - 78



Seduta a design variabile. Divano indeformabile di linea snella e arrotondata. Il comfort della seduta è enfatizzato dal lungo cuscino-schienale inserito a incastro. Il rivestimento d'insieme è con un pattern di tessuto d'arredamento a scelta di Missoni Home Collection. Disponibile in diverse dimensioni con variabili di larghezza.

Variable design seating. A sofa with slim and rounded line. The long back cushion emphasises the comfort of the seat. Upholstery can be chosen from furnishing fabrics from the Missoni Home Collection. Available in different widths.

INNTIL

DIVANO E POLTRONA SOFA AND ARMCHAIR

design by
BENDIK TORVIN
Made in Italy



INDOOR



RIVESTIMENTO SFODERABILE
REMOVABLE COVER

Materiali - Materials

Struttura: legno multistrato, sospensione su cinghie elastiche

Piedini: plastica antiscivolo e antigraffio

Imbottitura: poliuretano espanso indeformabile a quote differenziate, rivestito di ovatta in fibra di poliestere

Rivestimento: tessuto sfoderabile, lavabile secondo le indicazioni riportate sull'etichetta

Structure: plywood, elastic webbing suspension

Feet: anti-slip and non-scratch plastic

Padding: non-deformable polyurethane foam in different densities, covered with polyester fiber wadding

Upholstery: removable fabric, washable according to the instructions on label



POLTRONA ARMCHAIR

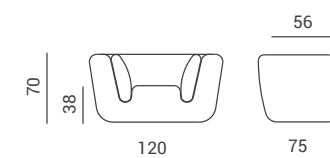

DIVANO 2 POSTI 2P SOFA

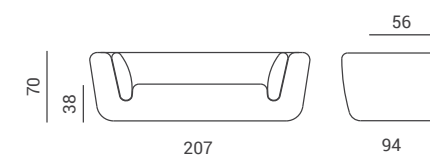

DIVANO 3 POSTI 3P SOFA

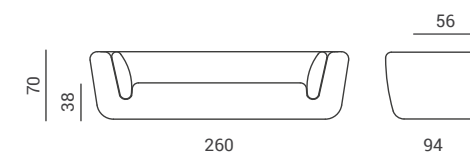

Divano 2 posti Sofa 2 seat
Peso netto Net weight **80 kg**
Peso con imballo Packed weight **90 kg**
Volume imballo Packed volume **2,15 m³**
Portata massima Maximum load **240 kg**

Divano 3 posti Sofa 3 seat
Peso netto Net weight **90 kg**
Peso con imballo Packed weight **103 kg**
Volume imballo Packed volume **2,4 m³**
Portata massima Maximum load **300 kg**

Poltrona Armchair
Peso netto Net weight **65 kg**
Peso con imballo Packed weight **73 kg**
Volume imballo Packed volume **0,75 m³**
Portata massima Maximum load **120 kg**

INNTIL

DIVANO MODULARE MODULAR SOFA

Altri prodotti della collezione Inntil: pag. 14 - 78
Other products from Inntil collection: pag. 14 - 78



Seduta modulare. La struttura del divano 3 posti indeformabile, di linea snella, ha un design allungato e funzionale, e può anche includere un modulo isola. Il comfort dello schienale è raddoppiato dal lungo cuscino imbottito inserito a incastro. I moduli sono agganciati fra loro. Il rivestimento d'assieme è in un tessuto d'arredamento Missoni Home Collection.

Modular seating. The structure of this non-deformable 3-seater modular element, with a slender line, has an elongated and functional design and can also be combined with a chaise longue. The comfort is doubled by the inclusion of a long back cushion. Each module can be hooked together and the upholstery chosen from furnishing fabrics in the Missoni Home Collection.

ELEMENTO ANGOLARE ANGULAR MODULE

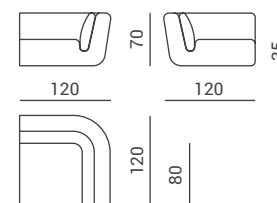

CHAISE LOUNGE DESTRO O SINISTRO CHAISE LOUNGE RIGHT OR LEFT

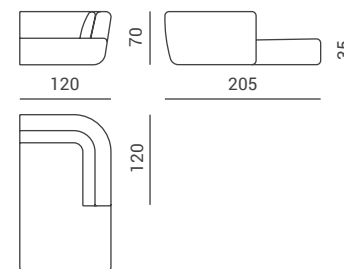

ELEMENTO 2 POSTI DESTRO O SINISTRO 2P MODULE RIGHT OR LEFT

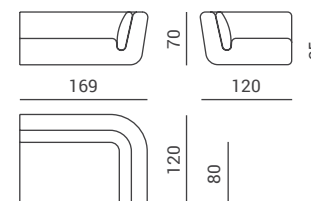

ELEMENTO 3 POSTI DESTRO O SINISTRO 3P MODULE RIGHT OR LEFT

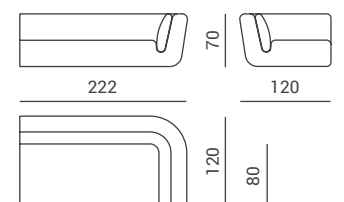

INNTIL

DIVANO MODULARE MODULAR SOFA

design by
BENDIK TORVIN
Made in Italy



INDOOR



RIVESTIMENTO SFODERABILE
REMOVABLE COVER

Materiali - Materials

Struttura: legno multistrato, sospensione su cinghie elastiche

Piedini: plastica antiscivolo e antigraffio

Imbottitura: poliuretano espanso indeformabile a quote differenziate, rivestito di ovatta in fibra di poliestere

Rivestimento: tessuto sfoderabile, lavabile secondo le indicazioni riportate sull'etichetta

Sistema di aggancio moduli: ad aggancio rapido

Structure: plywood, elastic webbing suspension

Feet: non-slip and non-scratch plastic

Padding: non-deformable polyurethane foam in different densities, covered with polyester fiber wadding

Upholstery: removable fabric, washable according to the instructions on label

Hooking system to link modules: quick interlocking



Elemento angolare
Peso netto
Peso con imballo
Volume imballo
Portata massima

Element - corner
Net weight
Packed weight
Packed volume
Maximum load

50 kg
60 kg
1,35 m³
120 kg

Elemento 2 posti
Peso netto
Peso con imballo
Volume imballo
Portata massima

Element - 2 seat
Net weight
Packed weight
Packed volume
Maximum load

70 kg
80 kg
1,9 m³
240 kg

Chaise longue
Peso netto
Peso con imballo
Volume imballo
Portata massima

Chaise longue
Net weight
Packed weight
Packed volume
Maximum load

67 kg
77 kg
2,2 m³
240 kg

Elemento 3 posti
Peso netto
Peso con imballo
Volume imballo
Portata massima

Element - 3 seat
Net weight
Packed weight
Packed volume
Maximum load

80 kg
90 kg
2,4 m³
300 kg

NAP INDOOR

DIVANO MODULARE MODULAR SOFA

Versione outdoor: pag. 92
Outdoor version: pag. 92



Volumi da comporre. La geometria del divano essenziale è variabile. Composta da moduli di volume diverso, collegabili con agganci a scomparsa, la seduta multipla dà spazio al tessuto. Il pattern è a scelta tra le proposte d'arredamento di Missoni Home Collection. Opzione, il maxi cuscino Saponetta per amplificare il comfort della seduta.

Volume and composition. The geometry of this clean-lined sofa is variable, composed of different volume modules and connected with retractable hooks. The simple shape gives space for the fabric to be the focus. Upholstery to be chosen from furnishing fabrics in the Missoni Home Collection. To increase the comfort of each module there is the option to include a back cushion "Saponetta".

CUSCINO SCHIENALE BACK CUSHION

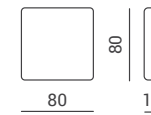

ELEMENTO POLTRONA ARMCHAIR MODULE

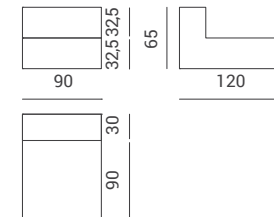

ELEMENTO DIVANO 3P 3PC SOFA MODULE

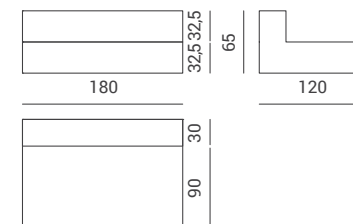

CHAISE LONGUE

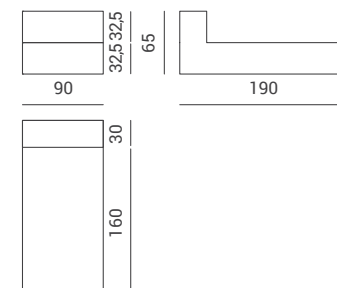

POUF PICCOLO SMALL POUF

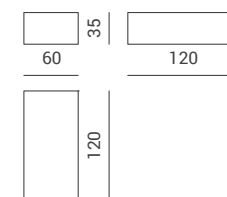

POUF GRANDE LARGE POUF

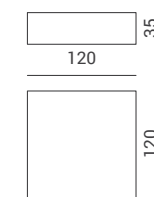

BRACCIOLO GRANDE LARGE ARM

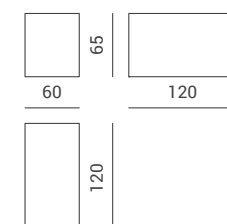

BRACCIOLO PICCOLO SMALL ARM

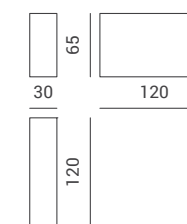

NAP INDOOR

DIVANO MODULARE MODULAR SOFA

design by
MISSONI STUDIO
Made in Italy

Materiali - Materials

Struttura: legno multistrato con sospensione su cinghie elastiche

Imbottitura: poliuretano espanso indeformabile a quote differenziate, rivestito di ovatta in fibra di poliestere

Rivestimento: tessuto sfoderabile, lavabile secondo le indicazioni riportate sull'etichetta

Sistema di aggancio fra moduli: ad incastro rapido, predisposti in base alla composizione scelta

Piedini: gomma morbida antiscivolo e antigraffio

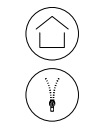

INDOOR



RIVESTIMENTO SFODERABILE
REMOVABLE COVER

Structure: plywood with elastic wadding suspension

Padding: non-deformable polyurethane foam in different densities, covered with polyester fiber wadding

Upholstery: removable fabric, washable according to the instructions on the label

Coupling system between modules: quick-interlock, arranged according to the chosen composition

Feet: anti-slip and non-scratch soft rubber



Modulo Unit	Peso netto Net weight	Peso con imballo Packed weight	Volume imballo Packed volume
Poltrona Chair	39 kg	46 kg	0,9 m ³
Divano 3 posti Sofa 3 seat	57 kg	66 kg	1,75 m ³
Chaise longue Chaise longue	47 kg	54 kg	1,4 m ³
Pouf piccolo Pouf small	16 kg	19 kg	0,35 m ³
Pouf grande Pouf large	21 kg	25 kg	0,65 m ³
Bracciolo piccolo Arm small	15 kg	19 kg	0,35 m ³
Bracciolo grande Arm large	18 kg	24 kg	0,6 m ³
Cuscino schienale Back cushion	2 kg	2 kg	0,09 m ³
Portata massima per modulo Maximum load per module		120 kg	

MISTER

DIVANO SOFA

Altri prodotti della collezione Mister: pag. 22

Other products from Mister collection: pag. 22



Dettaglio Detail

MISTER

DIVANO SOFA

design by
MISSONI STUDIO
Made in Italy

Materiali - Materials

Struttura: multistrato di abete e acciaio

Piedini: in acciaio con punti al suolo in MDF e feltrini in lana ad alta densità

Imbottitura: poliuretano ad alta densità a quote differenziate e piuma d'oca

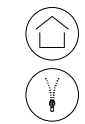

INDOOR



RIVESTIMENTO SFODERABILE
REMOVABLE COVER

Structure: fir multi-layered wood and steel

Feet: steel with MDF and high density wool feet

Padding: nhigh density polyurethane foam in varied densities and goose feather



DIVANO 2 POSTI 2P SOFA

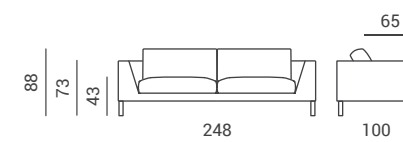

DIVANO 3 POSTI 3P SOFA

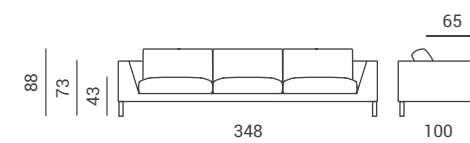

Dimensioni variabili. Il divano indeformabile di linea essenziale da indoor è progettato in questa versione in diverse dimensioni. L'opzione è tra la soluzione a due o tre posti del sofa e anche quella di una confortevole poltrona. Il rivestimento, facilmente sfoderabile, è realizzato a scelta con un pattern di tessuto della Missoni Home Collection. Piedini in acciaio cromato.

Various dimensions. The indeformable sofa of the essential indoor line is designed in this version in various sizes. The option is among the two or three seat sofa solution and also that of a comfortable armchair. The cover, easily removable, can be made by choosing from a pattern from the fabrics in the Missoni Home Collection. Feet in chrome-plated steel.

2 posti

Peso netto

Peso con imballo

Volume imballo

Portata massima

2 seats

Net weight

Packed weight

Packed volume

Maximum load

110 kg

120 kg

2,05 m³

240 kg

3 posti

Peso netto

Peso con imballo

Volume imballo

Portata massima

3 seats

Net weight

Packed weight

Packed volume

Maximum load

140 kg

152 kg

2,85 m³

300 kg

MISTER

DIVANO MODULARE MODULAR SOFA

Altri prodotti della collezione Mister: pag. 20

Other products from Mister collection: pag. 20



Moduli componibili. Queste sedute indeformabili di linea essenziale consentono una disposizione modulare con differenti opzioni. All'elemento divano di dimensioni variabili, si possono aggiungere una formula a chaise-longue e un pouf. L'insieme delle sedute risulta gradevole e leggero. Il rivestimento, facilmente sfoderabile, è a scelta in un pattern di tessuto della collezione. Piedini in acciaio cromato.

Sectional modules. The indeformable seating of an essential line allow for a modular arrangement with various options. It is possible to add a chaise-longue and pouf formula to the sofa element of variable dimensions. All of the seating options are pleasant and light. The cover, easily removable, can be chosen in a pattern from the fabrics in the collection. Feet in chrome-plated steel.

POUF
POUF



CHAISE LONGUE DESTRO O SINISTRO
CHAISE LONGUE RIGHT OR LEFT

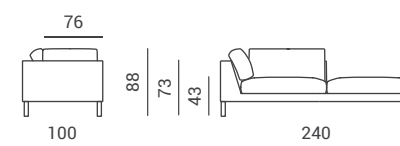

ELEMENTO 2 POSTI FINALE DESTRO O SINISTRO
2P MODULE RIGHT OR LEFT

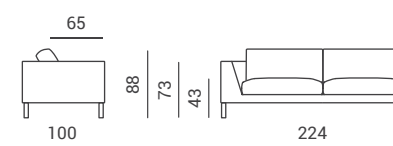

ELEMENTO 3 POSTI FINALE DESTRO O SINISTRO
3P MODULE RIGHT OR LEFT

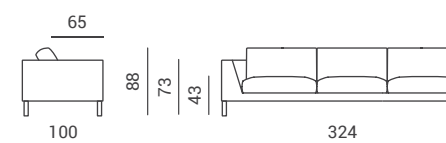

MISTER

DIVANO MODULARE MODULAR SOFA

design by
MISSONI STUDIO
Made in Italy



INDOOR



RIVESTIMENTO SFODERABILE
REMOVABLE COVER

Materiali - Materials

Struttura: multistrato di abete e acciaio
Piedini: in acciaio con punti al suolo in MDF e feltrini in lana ad alta densità
Imbottitura: poliuretano ad alta densità a quote differenziate e piuma d'oca
Sistema di aggancio moduli: ad aggancio rapido

Structure: fir multi-layered wood and steel
Feet: steel with MDF and high density wool feet
Padding: high density polyurethane foam in varied densities and goose feather
Hooking system to link modules: quick interlocking



Modulo Unit	Peso netto Net weight	Peso con imballo Packed weight	Volume imballo Packed volume
Divano 2 posti finale Sofa 2 seat end	90 kg	99 kg	1,86 m ³
Divano 3 posti finale Sofa 3 seat end	120 kg	132 kg	2,67 m ³
Chaise longue Chaise longue	85 kg	93 kg	1,41 m ³
Pouf Pouf	30 kg	36 kg	0,52 m ³
Portata massima per modulo Maximum load per module		120 kg	

TIAMAT

DIVANO SOFA

TIAMAT

DIVANO SOFA

design by
CRISTIANO MAGNONI
Made in Italy

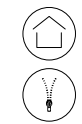

INDOOR

RIVESTIMENTO SFODERABILE
REMOVABLE COVER

Materiali - Materials

Struttura: legno multistrato con sospensione su cinghie elastiche

Imbottitura: poliuretano rivestito in ovatta in fibra di poliestere

Seduta: poliuretano espanso indeformabile a quote differenziate, rivestito di ovatta in fibra di poliestere

Cuscini: 100% piuma d'oca

Rivestimento: tessuto sfoderabile, lavabile secondo le indicazioni riportate sull'etichetta

Piedini: gomma morbida antiscivolo e antigraffio

Structure: multilayer with elastic wadding suspension

Padding: polyurethane covered with polyester fiber wadding

Seat: non-deformable polyurethane foam in different densities, covered with polyester fiber wadding

Cushions: 100% goose down

Upholstery: removable fabric, washable according to the instructions on the label

Feet: anti-slip and non-scratch soft rubber



Accogliente, soffice. La struttura in legno imbottita accoglie la confortevole seduta rotonda. Cinque grandi cuscini, uniti da un sistema di cerniere, disegnano l'avvolgente schienale e i braccioli d'appoggio. Sostegno complementare, i cuscini poggiatesta. Il rivestimento è a scelta tra i tessuti d'arredamento Missoni Home Collection. Completamente sfoderabile.

Welcoming, soft. A comfortable round seat wrapped in a padded wood structure. Five large back cushions, joined together by zips and supported by an enveloping backrest and armrests. In addition, the option to include lumbar cushions. The upholstery to be chosen from furnishing fabrics in the Missoni Home Collection. All covers removable.

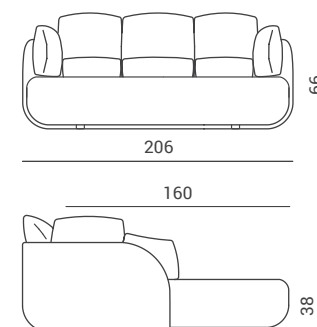

Peso netto	Net weight	105 kg
Peso con imballo	Packed weight	120 kg
Volume imballo	Packed volume	3,35 m³
Portata massima	Maximum load	300 kg

TOP 4 BIG

POLTRONA E DIVANO MODULARE ARMCHAIR AND MODULAR SOFA



Dettaglio Detail

POLTRONA CON BRACCIOLI
ARMCHAIR WITH ARMS

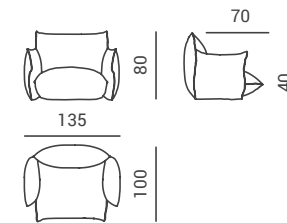

POLTRONA SENZA BRACCIOLI
ARMCHAIR WITHOUT ARMS

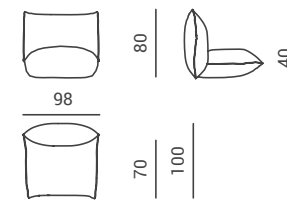

ELEMENTO POUF POUF UNIT

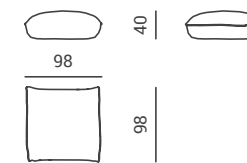

ELEMENTO CENTRALE CENTRAL SOFA UNIT

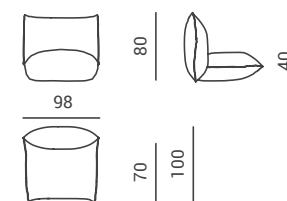

ELEMENTO FINALE SINISTRO CON BRACCIOLO
END SOFA UNIT WITH LEFT ARM

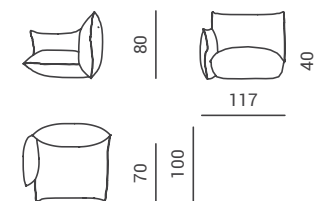

ELEMENTO FINALE DESTRO CON BRACCIOLO
END SOFA UNIT WITH RIGHT ARM

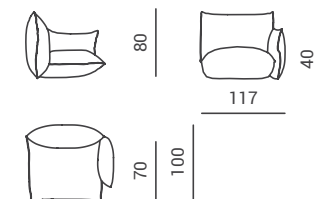

TOP 4 BIG

POLTRONA E DIVANO MODULARE ARMCHAIR AND MODULAR SOFA

design by
MISSONI STUDIO
Made in Italy



INDOOR



RIVESTIMENTO SFODERABILE
REMOVABLE COVER

Materiali - Materials

Struttura: legno multistrato con sospensione su cinghie elastiche

Imbottitura: poliuretano espanso indeformabile a quote differenziate, rivestito di ovatta in fibra di poliestere

Rivestimento: tessuto sfoderabile, lavabile secondo le indicazioni riportate sull'etichetta. Profilo bordato in cuoio

Sistema di aggancio fra moduli: ad aggancio rapido, con cerniere lampo fra gli schienali, predisposti in base alla composizione scelta

Piedini: gomma morbida antiscivolo e antigraffio

Structure: multilayer with elastic wadding suspension

Padding: non-deformable polyurethane foam in different densities, covered with polyester fiber wadding

Upholstery: removable fabric, washable according to the instructions on the label. Profile edged in leather

Linking system for modules: quick interlock, with zips between the backrests, arranged according to the chosen composition

Feet: anti-slip and non-scratch soft rubber



Easy mood, modulabile. Progettato esclusivamente su maxi cuscini da unire tramite cerniere a scomparsa, il morbido sistema di sedute voluminose dà un sostegno confortevole. Può essere disposto a divano o usato per seduta singola o pouf. Cuscini impreziositi dal profilo in cuoio. Rivestimento: a scelta tra i tessuti d'arredamento Missoni Home Collection.

Easy mood, modular. Exclusively designed around the concept of maxi cushions, the soft volumn seating provides comfortable support and is joined together by concealed zips. Each module can be used individually or arranged in composition as a sofa. The cushions are finished with a leather edging and the upholstery can be chosen from furnishing fabrics in the Missoni Home Collection.

Modulo Unit	Peso netto Net weight	Peso con imballo Packed weight	Volume imballo Packed volume
Poltrona con braccioli Chair with arms	34 kg	39 kg	1,25 m ³
Poltrona senza braccioli Chair without arms	24 kg	29 kg	1,15 m ³
Pouf Pouf	18 kg	21 kg	0,95 m ³
Centrale Central	25 kg	30 kg	0,65 m ³
Finale Final	30 kg	35 kg	1,15 m ³
Portata massima per modulo Maximum load per module		120 kg	

TEKTONIK

DIVANO MODULARE MODULAR SOFA

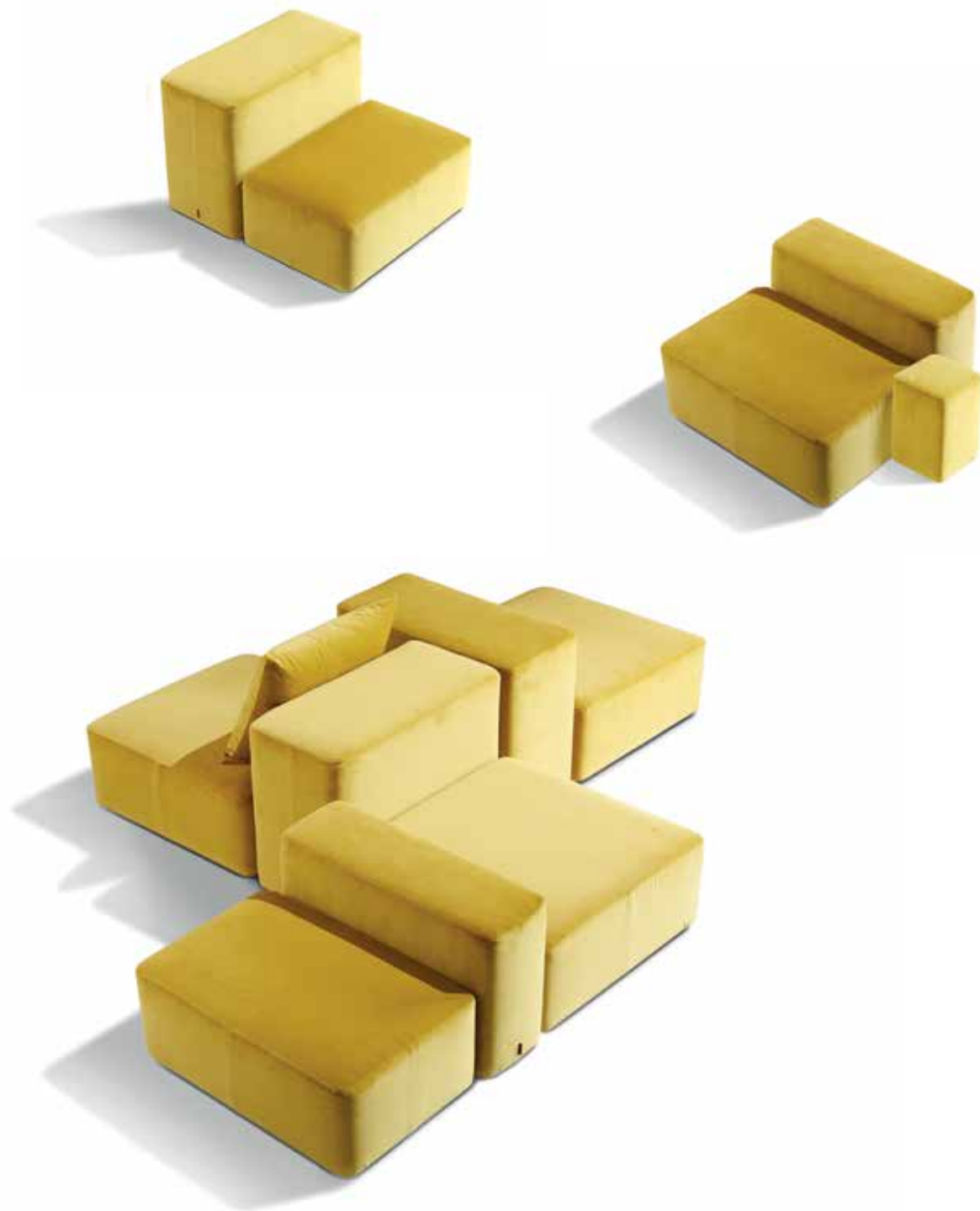

Semplice, composto. Sistema personalizzabile di sedute indipendenti, accostabili e bloccate da barre antisdrucciolo. I moduli solidi e scultorei consentono un gioco di alternanze e geometrie valorizzato dalla disposizione e dal rivestimento. Tessuti d'arredamento a scelta di Missoni Home Collection. Suggesta l'aggiunta di un cuscino poggiatesta per ogni seduta.

Simple, composed. This customisable system of independent seat modules are joined and locked by anti-slip bars. The solid and sculptural modules allow a play of different compositions and geometries and enhanced by the choice of Upholstery: to be chosen from furnishing fabrics in the Missoni Home Collection. The addition of back cushion is recommended for each seat module.

CUSCINO POGGIARENI BACK CUSHION

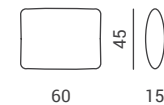

POUF

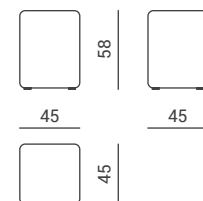

BRACCIOLO ARMREST

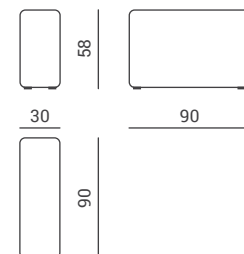

SCHIENALE BACK

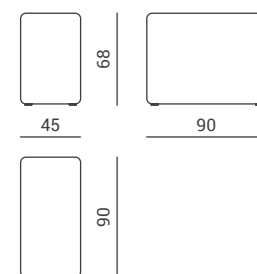

SEDUTA PICCOLA SMALL SEAT

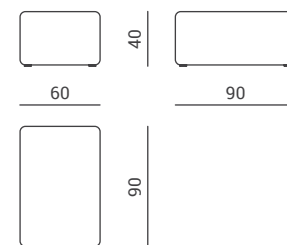

SEDUTA GRANDE LARGE SEAT

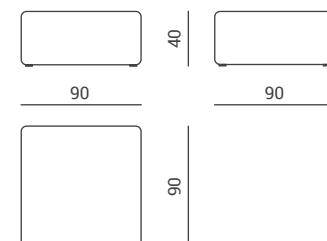

TEKTONIK

DIVANO MODULARE MODULAR SOFA

design by
BENDIK TORVIN
Made in Italy

Materiali - Materials

Struttura: legno multistrato con sospensione su cinghie elastiche

Imbottitura: poliuretano espanso indeformabile a quote differenziate, rivestito di ovatta in fibra di poliestere

Rivestimento: tessuto sfoderabile, lavabile secondo le indicazioni riportate sull'etichetta

Sistema di aggancio fra moduli: barre antiscivolo in appoggio

Piedini: gomma morbida antiscivolo e antigraffio



INDOOR



RIVESTIMENTO SFODERABILE
REMOVABLE COVER

Structure: multilayer with elastic wadding suspension

Padding: non-deformable polyurethane foam in different densities, covered with polyester fiber wadding

Upholstery: removable fabric, washable according to the instructions on the label

Coupling system between modules: non-slip support bars

Feet: non-slip and non-scratch soft rubber

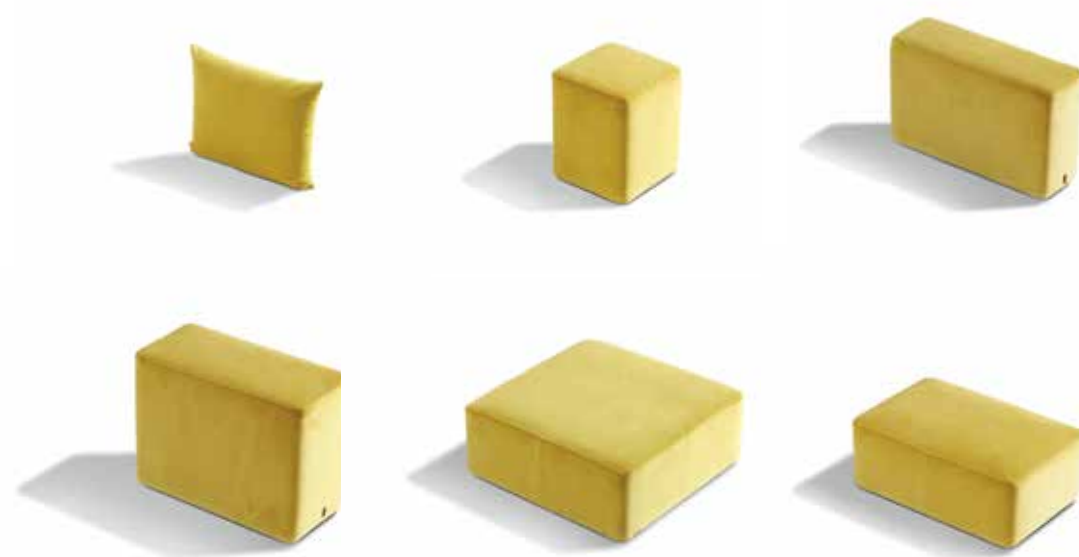

Modulo Unit	Peso netto Net weight	Peso con imballo Packed weight	Volume imballo Packed volume
Cuscino poggiatesta Back cushion	1 kg	1 kg	0,04 m ³
Pouf Pouf	12,5 kg	14,5 kg	0,15 m ³
Bracciolo Arm	16,5 kg	18,5 kg	0,2 m ³
Schienale Back	23 kg	25 kg	0,25 m ³
Seduta grande Large seat	20 kg	23 kg	0,4 m ³
Seduta piccola Small seat	14 kg	16 kg	0,25 m ³
Portata massima per modulo Maximum load per module		120 kg	

CORDULA

POLTRONA ROTONDA ROUND CHAIR

Versione in cuoio: pag. 94
Altri prodotti della collezione Cordula:
pag. 32 - 104 - 106 - 122
Leather version: pag. 94
Other products from Cordula collection:
pag. 32 - 104 - 106 - 122



Dettaglio Detail

CORDULA

POLTRONA ROTONDA ROUND CHAIR

design by
MISSONI STUDIO
Made in Italy

Materiali - Materials

Struttura: tondino in acciaio inox curvato a mano, finitura spazzolata

Rivestimento: corda in PET HT a motivo chevron multicolor

Piedini: in gomma antiscivolo e antigraffio

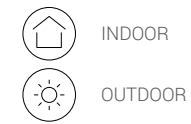

Structure: hand-curved stainless steel rod, brushed finish
Covering: PET HT rope with multicolour chevron motif
Feet: non-slip and non-scratch rubber



Essenziale, funzionale, ariosa. La poltrona ellittica prende forma da 3 anelli di acciaio incurvato sovrapposti e intelaiati da corde a micro-zigzag multicolor appositamente progettate e annodate a mano. La struttura design robusta e il materiale impermeabile rendono la seduta ubiqua, da interni e da esterni.

Essential, functional, airy. This elliptical armchair takes shape from 3 overlapping curved steel rings and framed by hand-knotted multicolour micro-zigzag rope. The sturdy design structure and waterproof material make the chair ideal for indoor and outdoor.

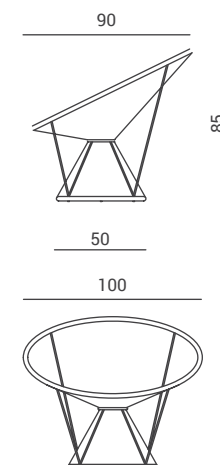

Peso netto	Net weight	10 kg
Peso con imballo	Packed weight	14 kg
Volume imballo	Packed volume	0,87 m³
Portata massima	Maximum load	100 kg

CORDULA

POLTRONCINA E POGGIPIEDI ARMCHAIR AND FOOTREST

Versione in cuoio: pag. 96
 Altri prodotti della collezione Cordula:
 pag. 30 - 104 - 106 - 122
 Leather version: pag. 96
 Other products from Cordula collection:
 pag. 30 - 104 - 106 - 122



Design anatomico. La poltroncina rigorosa con poggiatesta ha una struttura in acciaio curvato, la seduta è resa confortevole dall'energia elastica delle corde appositamente progettate. Annodate a mano e intessute con l'iconico motivo zigzag, le corde in materiale impermeabile consentono l'uso del duo anche in esterni.

Anatomical design. A sturdy armchair with footrest, produced from a curved steel structure. The elastic energy of the specially designed rope ensures comfort. The waterproof rope is hand-knotted and woven with the iconic zigzag motif and allows the product to be used indoor and outdoor.

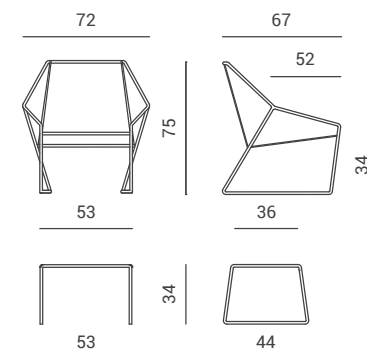

CORDULA

POLTRONCINA E POGGIPIEDI ARMCHAIR AND FOOTREST

design by
MISSONI STUDIO
 Made in Italy

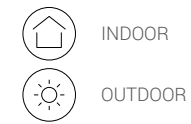

Materiali - Materials

Struttura: tondino in acciaio inox curvato a mano, finitura spazzolata
 Rivestimento: corda in PET HT a motivo chevron multicolor
 Piedini: in materiale plastico, antiscivolo e antigraffio

Structure: hand-curved stainless steel rod, brushed finish
 Covering: PET HT rope with multicolor chevron motif
 Feet: anti-slip and non-scratch plastic

Dettaglio Detail



Poltroncina Armchair
Peso netto Net weight **8 kg**
Peso con imballo Packed weight **12 kg**
Volume imballo Packed volume **0,4 m³**
Portata massima Maximum load **100 kg**

Poggiapiedi Footstool
Peso netto Net weight **6,7 kg**
Peso con imballo Packed weight **8 kg**
Volume imballo Packed volume **0,1 m³**
Portata massima Maximum load **100 kg**

GRANDMA

DIVANETTO, POLTRONA, POGGIPIEDI E TAVOLINO SOFA, ARMCHAIR, FOOTREST AND LOW TABLE



Classico moderno. La confortevole poltrona decorativa di forma squadrata si appoggia a braccioli incurvati in legno massello (finitura rovere o noce americana). Il pattern del rivestimento materico è a scelta tra i tessuti d'arredamento Missoni Home Collection. Opzione, l'elemento poggiatesta che la trasforma in chaise-longue, o con funzione di pouf.

A modern classic. The comfortable square-shaped decorative armchair rests on curved solid wood armrests (oak or american walnut finish). Furnishing fabrics from the Missoni Home Collection can be chosen for the upholstery. The footrest element can be used alongside to form a chaise longue or as a pouf.



LIGHT

DARK

DIVANETTO SOFA

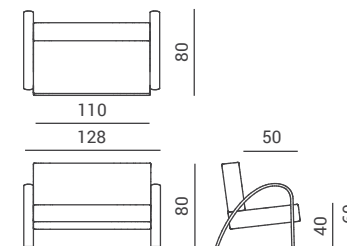

POLTRONA ARMCHAIR

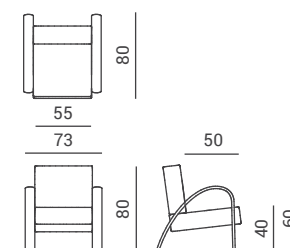

POGGIPIEDI FOOTREST

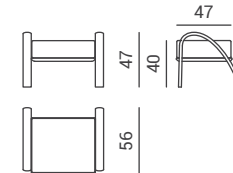

TAVOLINO LOW TABLE

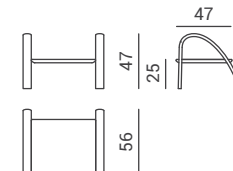

GRANDMA

DIVANETTO, POLTRONA, POGGIPIEDI E TAVOLINO SOFA, ARMCHAIR, FOOTREST AND LOW TABLE

design by
MISSONI STUDIO
Made in Italy



INDOOR



RIVESTIMENTO SFODERABILE
REMOVABLE COVER

Materiali - Materials

Struttura: legno multistrato / legno massello di rovere o noce americana

Braccioli, legno massello di rovere o noce americana

Imbottitura: poliuretano espanso indeformabile, rivestito di ovatta in fibra di poliestere

Rivestimento: tessuto sfoderabile, lavabile secondo le indicazioni riportate sull'etichetta

Piedini: in lana ad alta densità, antiscivolo e antigraffio

Structure: plywood / solid oak or American walnut

Armrests, solid oak or American walnut

Padding: non-deformable polyurethane foam covered with polyester fiber wadding

Upholstery: removable fabric, washable according to the instructions on the label

Feet: anti-slip and non-scratch high-density wool



Divanetto
Peso netto 22,5 kg
Peso con imballo 30 kg
Volume imballo 0,4 m³
Portata massima 200 kg

Sofa

Net weight

Packed weight

Packed volume

Maximum load

Poggiatesta
Peso netto 7 kg
Peso con imballo 9 kg
Volume imballo 0,5 m³

Footstool

Net weight

Packed weight

Packed volume

Poltrona
Peso netto 14 kg
Peso con imballo 20 kg
Volume imballo 0,5 m³
Portata massima 100 kg

Armchair

Net weight

Packed weight

Packed volume

Maximum load

Tavolino
Peso netto 8 kg
Peso con imballo 10 kg
Volume imballo 0,5 m³

Low table

Net weight

Packed weight

Packed volume

MILADY

POLTRONA E DIVANETTO ARMCHAIR AND SOFA



Profilo e forma. Come un guscio confortevole, la poltrona ha una silhouette insolita e avvolgente dove risalta il tessuto. La struttura scultorea in legno è imbottita in poliuretano espanso a quote e fibra di poliestere. Il rivestimento posizionato ad arte, è a scelta tra le proposte Missoni Home Collection. Disponibile in 2 diverse dimensioni.

Profile and form. Like a comfortable shell, the armchair has an unusual and enveloping silhouette with a focus on the fabric. The sculptural wood structure is padded with polyurethane foam and polyester fiber. Artfully positioned, the upholstery can be chosen from furnishing fabrics in the Missoni Home Collection. Available in 2 sizes.

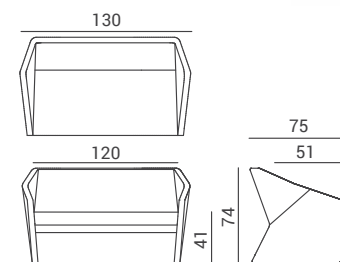
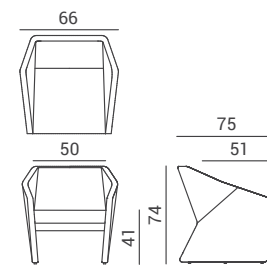

MILADY

POLTRONA E DIVANETTO ARMCHAIR AND SOFA

design by
MISSONI STUDIO
Made in Italy



Materiali - Materials

Struttura: legno multistrato, sospensione su cinghie elastiche

Imbottitura: poliuretano espanso indeformabile e fibra poliestere

Piedini: lana ad alta densità

Rivestimento sedile e schienale: tessuto sfoderabile, lavabile secondo le indicazioni riportate sull'etichetta

Rivestimento gambe: tessuto non sfoderabile, lavabile con un panno umido

Structure: plywood, elastic wadding suspension

Feet: high density wool

Padding: non-deformable polyurethane foam in different densities, covered with polyester fiber wadding

Upholstery: non-removable fabric, washable with a damp cloth



Poltrona
Peso netto
Peso con imballo
Volume imballo
Portata massima

Chair
Net weight
Packed weight
Packed volume
Maximum load

22 kg
26 kg
0,45 m³
120 kg

Divanetto
Peso netto
Peso con imballo
Volume imballo
Portata massima

Small sofa
Net weight
Packed weight
Packed volume
Maximum load

29 kg
33 kg
0,75 m³
200 kg

VIRGOLA

SEDUTA E CHAISE LONGUE SEATING AND LOUNGER

Versione Soft: pag. 98

Soft version: pag. 98



Gioco e forma. Sagomata in morbido poliuretano ignifugo la seduta è facile da spostare e consente composizioni variabili. I moduli sono in versione compatta a poltrona o allungata a chaise longue. Il rivestimento è a scelta tra i tessuti d'arredamento Missoni Home Collection. Completamente sfoderabile, ha la parte inferiore idrorepellente, antimuffa e antimacchia per l'appoggio diretto a terra.

Game and form. Shaped in soft fireproof polyurethane, the seat is light, easy to move and offers the possibility of variable compositions. Available as a compact armchair or as an elongated chaise-longue. Upholstery can be chosen from furnishing fabrics in the Missoni Home Collection and is removable. The base is made from a water-repellent, anti-mould, anti-stain fabric so it can be positioned directly on the floor.

VIRGOLA

SEDUTA E CHAISE LONGUE SEATING AND LOUNGER

design by
MISSONI STUDIO
Made in Italy

Materiali - Materials

Struttura: poliuretano ignifugo
Imbottitura: ovatta in fibra di poliestere
Rivestimento: tessuto sfoderabile, lavabile secondo le indicazioni indicate sull'etichetta. Parte inferiore in tessuto idrorepellente e antimacchia



INDOOR



RIVESTIMENTO SFODERABILE
REMOVABLE COVER

*Structure: fireproof polyurethane
Padding: polyester fiber wadding
Upholstery: removable fabric, washable according to the instructions indicated on the label. Base in water-repellent and stain-resistant fabric*



POLTRONA ARMCHAIR

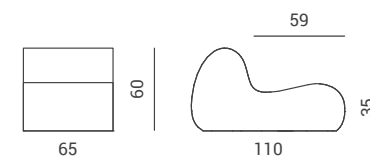

CHAISE LONGUE LOUNGER



Poltrona Armchair
Peso netto Net weight **8,5 kg**
Peso con imballo Packed weight **13,5 kg**
Volume imballo Packed volume **0,5 m³**
Portata massima Maximum load **120 kg**

Chaise longue Chaise longue
Peso netto Net weight **12 kg**
Peso con imballo Packed weight **18 kg**
Volume imballo Packed volume **0,75 m³**
Portata massima Maximum load **120 kg**

JALAMAR INDOOR

CHAISE LONGUE LOUNGER

Versione outdoor: pag. 100

Outdoor version: pag. 100



Comfort da interni. La chaise longue anatomica è anche un elemento decorativo. Il materassino azionato da meccanismi interni assume diverse inclinazioni, 5 per lo schienale, 3 per il poggiatesta. Il rivestimento è a scelta tra i tessuti d'arredamento Missoni Home Collection. La parte inferiore della cover è idrorepellente, antimuffa e antimacchia, per appoggio a terra.

Indoor comfort. This chaise longue offers anatomical comfort and a decorative aesthetic. The mattress is operated by an internal mechanism that adjusts inclinations, 5 positions for the backrest and 3 for the leg-rest. Upholstery to be chosen from furnishing fabrics in the Missoni Home Collection. As it is positioned directly on the floor, the base is made from water-repellent, anti-mould and anti-stain fabric.

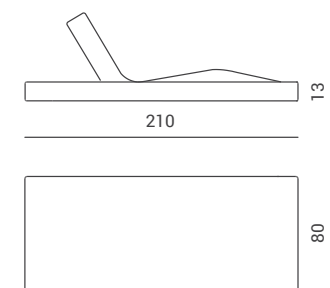

JALAMAR INDOOR

CHAISE LONGUE LOUNGER

design by
CRISTIANO MAGNONI
Made in Italy

Materiali - Materials

Struttura: in acciaio con meccanismi a scatto da 5 posizioni per lo schienale e 3 posizioni per le gambe
Imbottitura: poliuretano espanso indeformabile, rivestito di ovatta in fibra di poliestere
Rivestimento: tessuto sfoderabile, lavabile secondo le indicazioni riportate sull'etichetta. Parte inferiore in tessuto idrorepellente antimacchia

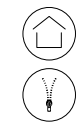

INDOOR



RIVESTIMENTO SFODERABILE
REMOVABLE COVER

Structure: in steel with 5-position adjustable mechanism for the backrest and 3-position for the leg rest

Padding: non-deformable polyurethane foam covered with polyester fiber wadding

Upholstery: removable fabric, washable according to the instructions on the label

Base in water-repellent stain-resistant fabric



Peso netto	Net weight	20 kg
Peso con imballo	Packed weight	24 kg
Volume imballo	Packed volume	0,3 m³
Portata massima	Maximum load	100 kg

ART GLASS

TAVOLINO LOW TABLE

Altri prodotti della collezione Art Glass:
pag. 48 Holly Art Glass

Other products from Art Glass collection:
pag. 48 Holly Art Glass



Luminosità e tecnica artigiana. I suggestivi tavolini in resina su vetro sono frutto di tecniche artigiane. Il piano tondo e sfavillante alterna mix di sfumature infuocate, blu cielo e dark. L'effetto scenografico è dato da resine pigmentate colate in vari strati sopra il vetro. La movimentazione manuale della materia crea un pattern decorativo di alto valore estetico e profonda luminosità. Lucidatura a mano. Poggia su struttura in metallo con gambe ad ellisse. 3 dimensioni e 3 set di colorazioni.

Luminosity with artisan technique. The evocative resin on glass coffee tables are the result of artisan techniques. The round gleaming top alternates a mix of fiery shades, sky blue and dark. A scenographic effect is achieved by pigmented resins cast in various layers over the glass. The material is handled manually and this results in a decorative pattern of high aesthetic value and deep luminosity. Polished by hand, it rests on a metal structure with ellipse profile legs. Available in 3 sizes and 3 set of colours.



GRIGIO 132

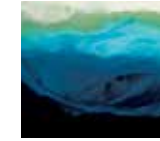

BLU 150



ROSSO 156



RUGGINE 64



ORO 40



ARGENTO 31

ART GLASS

TAVOLINO LOW TABLE

design by
MISSONI STUDIO
Made in Italy

Materiali - Materials

Struttura: telaio in acciaio a sezione ellittica
Piano d'appoggio: disco in vetro temprato accoppiato con resine, lavorate interamente a mano
Piedini: in lana ad alta densità, antiscivolo e antigraffio



INDOOR

Structure: steel elliptical frame

Top: tempered glass paired with hand crafted resin works

Feet: anti-slip and non-scratch high-density wool

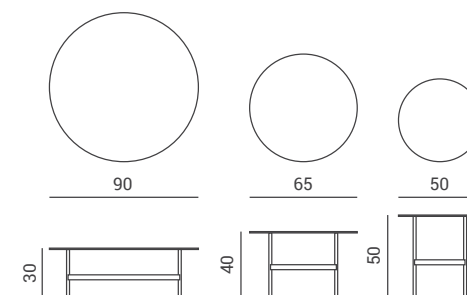

Versione da Ø 90 cm
Peso netto 13 kg
Peso con imballo 13 kg
Volume imballo 0,3 m³

Version Ø 90 cm
Net weight
Packed weight
Packed volume

Versione da Ø 50 cm
Peso netto 5 kg
Peso con imballo 7 kg
Volume imballo 0,2 m³

Version Ø 50 cm
Net weight
Packed weight
Packed volume

Versione da Ø 65 cm
Peso netto 7 kg
Peso con imballo 9 kg
Volume imballo 0,2 m³

Version Ø 65 cm
Net weight
Packed weight
Packed volume

CORDULA CUOIO

TAVOLINO ROTONDO LOW ROUND TABLE

Altri prodotti della collezione Cordula Cuoio:
pag. 46 - 94 - 96

Other products from Cordula Cuoio collection:
pag. 46 - 94 - 96



Cuoio e cristallo. L'elegante tavolo design in dimensione coffee table ha struttura in acciaio curvato ad anelli sovrapposti e base conica. Una stringa di cuoio annodata a mano crea il prezioso intreccio a raggiera che traspare dal piano in cristallo. Esclusivamente da interni.

Leather and glass. The elegant design of this coffee table has a curved steel structure: made from overlapping rings and a conical base. Hand-knotted leather cord creates a precious radial weave that can be viewed through the glass top. For indoor use only.



Dettaglio Detail

CORDULA CUOIO

TAVOLINO ROTONDO LOW ROUND TABLE

design by
MISSONI STUDIO
Made in Italy

Materiali - Materials

Struttura: tondino in acciaio inox curvato, finitura spazzolata, verniciata in abbinamento alla corda
Rivestimento: corda in cuoio
Piano d'appoggio: vetro extra chiaro
Piedini: in gomma antiscivolo e antigraffio



INDOOR

Structure: curved stainless steel rod, brushed finish, painted in combination with the cord colour
Covering: leather cord
Table top: extra clear glass
Feet: non-slip and non-scratch rubber

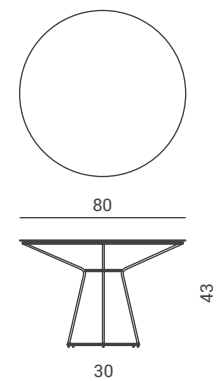

Peso netto	Net weight	16 kg
Peso con imballo	Packed weight	20 kg
Volume imballo	Packed volume	0,55 m ³

CORDULA CUOIO

TAVOLINI QUADRATI SQUARED TABLES

Altri prodotti della collezione Cordula Cuoio:
pag. 44 - 94 - 96

Other products from Cordula Cuoio collection:
pag. 44 - 94 - 96



Dettaglio Detail

CORDULA CUOIO

TAVOLINI QUADRATI SQUARED TABLES

design by
MISSONI STUDIO
Made in Italy

Materiali - Materials

Struttura: tondino in acciaio inox curvato, finitura spazzolata, verniciata in abbinamento alla corda

Rivestimento: corda in cuoio

Piedini: in materiale plastico, antiscivolo e antigraffio



INDOOR

Structure: curved stainless steel rod, brushed finish, painted in combination with the cord colour

Covering: leather cord

Feet: anti-slip and non-scratch plastic



Gioco design minimal chic. I tavolini con struttura in acciaio curvato e spazzolato hanno la geometrica perfezione del cubo cavo. Il piano d'appoggio è creato dall'intelaiatura di corda in cuoio scuro annodata a mano. Il set si compone di due elementi, da sdoppiare o da riporre uno dentro l'altro.

A game of minimal chic. Formed in a curved, brushed steel Structure: the tables offer geometric perfection of the hollow cube. The table top is created by hand-knotted dark leather rope. The set of two tables can be used individually or placed one inside the other.

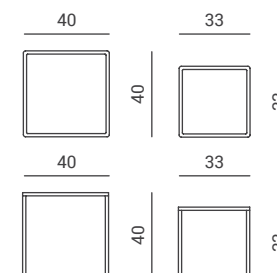

Peso netto	Net weight	9,5 kg
Peso con imballo	Packed weight	13 kg
Volume imballo	Packed volume	0,1 m³
Portata massima	Maximum load	100 kg

Non vendibili singolarmente

Not sold individually

HOLLY ART GLASS

TAVOLINO LOW TABLE

Altri prodotti della collezione Art Glass: pag. 42 Art Glass
Other products from Art Glass collection: pag. 42 Art Glass



Decor e tecnica artigiana. I suggestivi tavolini in resina su vetro sono frutto di tecniche artigiane. Il piano tondo e sfavillante alterna mix di sfumature luminose e dark. L'effetto scenografico è dato da resine pigmentate colate in vari strati sopra il vetro. La movimentazione manuale della materia crea un pattern decorativo di alto valore estetico e profonda luminosità. Lucidatura a mano. È sostenuto da struttura metallica incurvata e di sagoma essenziale, con finitura cromata. Proposto in 2 diverse misure.

Décor and artisan technique. The evocative resin on glass coffee tables are the result of artisan techniques. The round gleaming top alternates a mix of fiery shades, sky blue and dark. A scenographic effect is achieved by pigmented resins cast in various layers over the glass. The material is handled manually and this results in a decorative pattern of high aesthetic value and deep luminosity. Polished by hand, it is supported by a simple curved metal structure with a chrome finish. Available in 2 sizes.

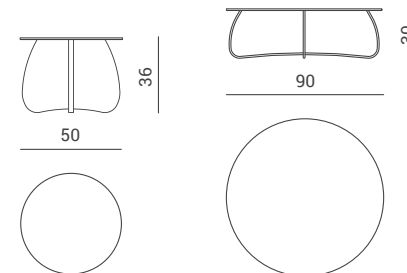

HOLLY ART GLASS

TAVOLINO LOW TABLE

design by
MISSONI STUDIO
Made in Italy

Materiali - Materials

Struttura: telaio in acciaio
Piano d'appoggio: disco in vetro temprato accoppiato con resine, lavorate interamente a mano
Piedini: in lana ad alta densità, antiscivolo e antigraffio



Structure: steel frame
Top: tempered glass paired with hand crafted resin works
Feet: anti-slip and non-scratch high-density wool



GRIGIO 132



RUGGINE 64

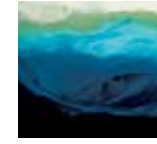

BLU 150



ORO 40



ROSSO 156



ARGENTO 31



Versione Ø 50 cm
Peso netto
Peso con imballo
Volume imballo

Version Ø 50 cm
Net weight
Packed weight
Packed volume

5,5 kg
8 kg
0,2 m³

Versione Ø 90 cm
Peso netto
Peso con imballo
Volume imballo

Version Ø 90 cm
Net weight
Packed weight
Packed volume

10 kg
18 kg
0,5 m³

SPOOL CEDAR

TAVOLINO LOW TABLE



Sostenibilità e materia. Il subbio, una componente del telaio tessile, diventa tavolino scultura in profumato legno di cedro. La tornitura sul legno massello simula a sbalzo gli avvolgimenti del filo. Dalla caratteristica gradevole essenza, il legno di cedro naturale è un pregiato materiale vivo con fessure che possono modificarsi nel tempo in base alle condizioni ambientali. Ogni elemento è un pezzo unico.

Sustainability and matter. The spool, a component of a textile loom, becomes a sculptural table in fragrant cedar wood. Turning on solid cedar wood stimulates the cantilevered winding of the threads. With its characteristic pleasant essence, natural cedar wood is a precious living material with cracks that can change over time according to the environmental conditions. Each piece is unique.

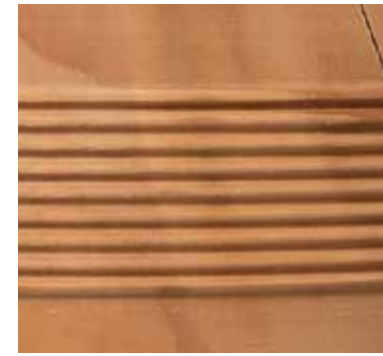

Dettaglio *Detail*

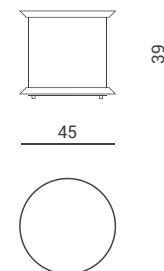

SPOOL CEDAR

TAVOLINO LOW TABLE

design by
MISSONI STUDIO
Made in Italy



INDOOR

Materiali - Materials

Struttura interna, legno massello di cedro tornito
Piedini: lana ad alta densità

*Structure: solid turned cedar wood
Feet: high-density wool*



Peso netto	<i>Net weight</i>	30 kg
Peso con imballo	<i>Packed weight</i>	32 kg
Volume imballo	<i>Packed volume</i>	0,2 m³

HARRY GLASS INDOOR

TAVOLINO LOW TABLE

Combinabile con divano Adar: pag. 10
Versione outdoor: pag. 102

Combinable with Adar sofa: pag. 10
Outdoor version: pag. 102



Componibile, multiuso. Il tavolino ha un piano in vetro serigrafato a motivo zigzag tono-su-ono, sorretto da struttura metallica verniciata satinata color fango. Disponibile in 4 misure e altezze in scala, consente uso singolo ma anche combinazione plurima e sovrapposta.

Modular and multi-purpose. The coffee table has a screen-printed glass top with a tonal zigzag motif, supported by a brown satin painted metal structure. Available in 4 sizes and heights, it can be used individually, or in multiple with overlapping combinations.



Dettaglio Detail

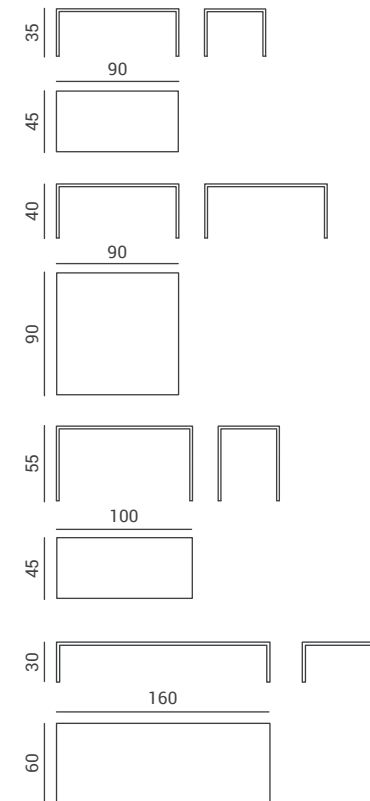

HARRY GLASS INDOOR

TAVOLINO LOW TABLE

design by
MISSONI STUDIO
Made in Italy

Materiali - Materials

Base: telaio in acciaio verniciato a polvere in colore Charcoal

Piedini: in materiale plastico e lana ad alta densità, antiscivolo e antigraffio

Piano d'appoggio: vetro fumè temprato, antigraffio e oleofobico, con stampa ceramizzata a motivo



INDOOR

Base: steel frame, powder coated in charcoal colour

Feet: anti-slip and non-scratch plastic and high-density wool

Table top: tempered smoked, anti-scratch and oleophobic glass, with ceramized print



Versione 90x90 cm
Peso netto **28 kg**
Peso con imballo **33,5 kg**
Volume imballo **0,5 m³**

Version 90x90 cm
Net weight
Packed weight
Packed volume

Versione 100x45 cm
Peso netto **18,5 kg**
Peso con imballo **24 kg**
Volume imballo **0,48 m³**

Version 100x45 cm
Net weight
Packed weight
Packed volume

Versione 90x45 cm
Peso netto **17 kg**
Peso con imballo **22 kg**
Volume imballo **0,23 m³**

Version 90x45 cm
Net weight
Packed weight
Packed volume

Versione 160x60 cm
Peso netto **34 kg**
Peso con imballo **44 kg**
Volume imballo **0,48 m³**

Version 160x60 cm
Net weight
Packed weight
Packed volume

LONG / WIDE

TAVOLINO LOW TABLE



Essenziale, multifunzione. Il tavolo d'appoggio a parallelepipedo è impiallacciato in legno di rovere. La stampa in superficie del tipico motivo fiammato Missoni velata tono-su-tono lascia trasparire le venature. Il diverso gioco di pieni e vuoti, sul lato lungo o corto, offre l'alternativa Long/Wide. Disponibilità in tono rovere naturale o wengé.

Essential, multifunction. This oak-veneered side table, parallelepiped design, has the beauty of the grain of the wood visible and a typical Missoni flame tonal surface printed. The different play of solid and void space, on the long or the short side, offers the Long or Wide alternatives. Available in natural oak or wengé tone.

LONG / WIDE

TAVOLINO LOW TABLE

design by
MISSONI STUDIO
Made in Italy

Materiali - Materials

Struttura: legno multistrato impiallacciato in rovere, tinto color testa di moro o miele, sovrastampato con motivo fiammato e finitura protettiva trasparente
Piedini: in lana ad alta densità



INDOOR

*Structure: oak veneered plywood, available in dark brown or light honey colour, overprinted with flamed motif and a transparent protective finish
Feet: high-density wool*



Dettaglio *Detail*



NERO 38



ROVERE
CHIARO 48



LONG

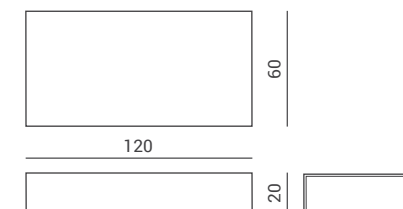

WIDE

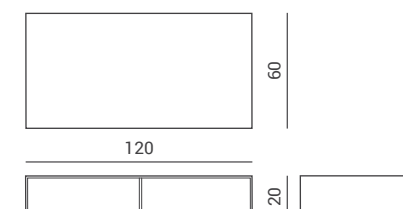

Peso netto	<i>Net weight</i>	42 kg
Peso con imballo	<i>Packed weight</i>	50 kg
Volume imballo	<i>Packed volume</i>	0,25 m³

LOW

TAVOLINO LOW TABLE



Sottilmente versatile. Lunga striscia impiallacciata in legno di rovere e stampata in superficie con il tipico motivo fiammato Missoni in toni velati che lasciano trasparire le venature. Per la sua lunghezza estrema funge da punto d'appoggio suggestivo appena sollevato da terra. Nei colori rovere naturale o wengé.

Subtly versatile. This long table is veneered in oak, the beauty of the grain of the wood is visible and a typical Missoni flame tonal surface printed. The long length of the table, just lifted off the ground, is suggestive of a foot-hold. Available in natural oak or wengé.

LOW

TAVOLINO LOW TABLE

design by
MISSONI STUDIO
Made in Italy

Materiali - Materials

Struttura: legno multistrato impiallacciato in rovere, tinto color testa di moro o miele, sovrastampato con motivo fiammato e finitura protettiva trasparente
Piedini: in lana ad alta densità



INDOOR

*Structure: oak veneered plywood, available in dark brown or light honey colour, overprinted with flamed motif and a transparent protective finish
Feet: high density wool*

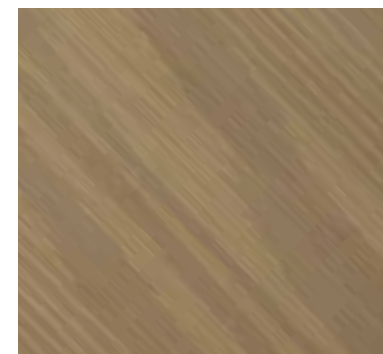

Dettaglio *Detail*



NERO 38



ROVERE
CHIARO 48

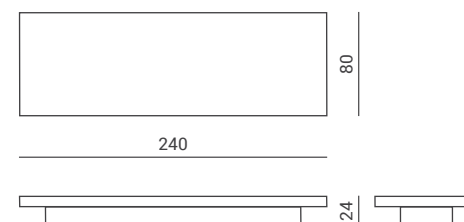

Peso netto	<i>Net weight</i>	23,5 kg
Peso con imballo	<i>Packed weight</i>	32 kg
Volume imballo	<i>Packed volume</i>	0,8 m³

GEMMA

POUF POUF



Design essenziale, easy. Il pouf a mezzo cono con la linea pulita e scultorea di un solido ha una seduta confortevole e indeformabile. Da sottolineare la sua stabilità ottimizzata dal sostegno laccato che sorregge e delinea la base. Il rivestimento è a scelta tra le proposte Missoni Home Collection.

Essential, easy design. The half-cone pouf, with the clean and sculptural line of a solid block, has a comfortable and non-deformable seat. The lacquered plinth optimises its stability and emphasises the solidity of the base. The pouf can be upholstered with any suitable furnishing fabric of the Missoni Home Collection.

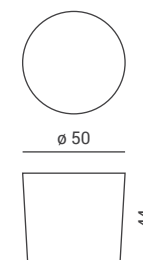

GEMMA

POUF POUF

design by
MISSONI STUDIO
Made in Italy

Materiali - Materials

Base: fibra di legno, finitura laccata

Imbottitura: poliuretano espanso indeformabile, rivestito di ovatta in fibra di poliestere

Piedini: lana ad alta densità

Rivestimento: tessuto sfoderabile, lavabile secondo le indicazioni riportate sull'etichetta



INDOOR



RIVESTIMENTO SFODERABILE
REMOVABLE COVER

Base: wooden fiber, lacquered finish

Padding: non-deformable polyurethane foam covered with polyester fiber wadding

Feet: high-density wool

Upholstery: removable fabric, washable according to the instructions on the label



Peso netto	<i>Net weight</i>	10 kg
Peso con imballo	<i>Packed weight</i>	12 kg
Volume imballo	<i>Packed volume</i>	0,125 m³
Portata massima	<i>Maximum load</i>	120 kg

PUNTASPILLONE

POUF POUF



Decor e relax (shape da relax). Ispirato alla forma del cuscinetto puntaspilli ma di proporzioni giganti, il pouf è l'allegoria macro del tipico elemento sartoriale. È composto da morbidi spicchi imbottiti di gommapiuma e rivestiti artigianalmente con tessuto a scelta della Missoni Home Collection. Rivestimento posizionato ad arte.

Relaxed decoration (a restful shape). Inspired by the shape of a pincushion, but in giant scale, this pouf is the macro allegory of this typical tailoring tool. It is made up of soft padded segments of foam and upholstered by hand with fabric chosen from the Missoni Home Collection. The fabric design will be artfully positioned.

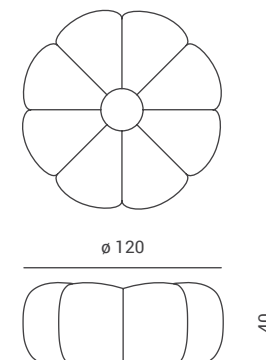

PUNTASPILLONE

POUF POUF

design by
MISSONI STUDIO
Made in Italy



INDOOR

Materiali - Materials

Struttura: legno multistrato

Piedini: lana ad alta densità

Imbottitura: poliuretano espanso indeformabile, rivestito di ovatta in fibra di poliestere

Rivestimento: tessuto non sfoderabile, lavabile con un panno umido

Structure: plywood

Feet: high-density wool

Padding: non-deformable polyurethane foam covered with polyester fiber wadding

Upholstery: non-removable fabric, washable with a damp cloth



Peso netto	Net weight	18 kg
Peso con imballo	Packed weight	20 kg
Volume imballo	Packed volume	0,7 m³
Portata massima	Maximum load	120 kg

DINING
ROOM



FRAMED MIRROR

SPECCHIO MIRROR



Decorativo, variabile. La cornice bombata in legno che racchiude e sostiene la superficie specchiante è un suggestivo complemento d'arredo. Il rivestimento nel motivo preferito è da selezionare con tessuto a scelta della Missoni Home Collection. La forma può essere circolare o a rettangolo. Disponibile in 4 diverse varianti.

Decorative and versatile. The curved wooden cornice, that encloses and supports the mirror is a charming piece of furniture. The frame can be upholstered in furnishing fabrics from the Missoni Home Collection. Available circular in shape or rectangular in shape (4 different sizes).

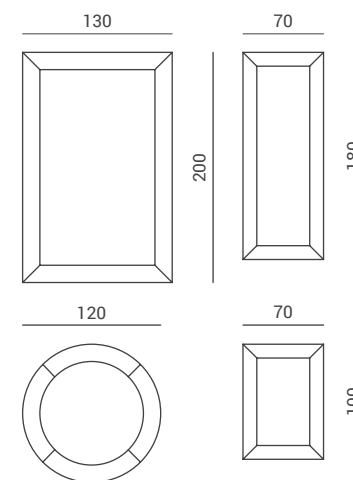

FRAMED MIRROR

SPECCHIO MIRROR

design by
MISSONI STUDIO
Made in Italy

Materiali - Materials

Struttura: legno massello
Specchio: vetro antinfortunistico
Agganci: a scomparsa, utilizzabile in senso verticale o orizzontale
Rivestimento: tessuto non sfoderabile, lavabile con un panno umido. Pannello posteriore antigraffio



INDOOR

Structure: solid wood
Mirror: safety glass
Hooks: retractable, can be used vertically or horizontally
Upholstery: non-removable fabric, washable with a damp cloth. Scratch-resistant rear panel



Versione Version	Peso netto Net weight	Peso con imballo Packed weight	Volume imballo Packed volume
Ø 120	12,5 kg	64,5 kg	0,6 m ³
70x100	11 kg	37 kg	0,3 m ³
70x180	16 kg	59 kg	0,55 m ³
130x200	21 kg	99 kg	0,9 m ³

MISS WOOD

TAVOLO TABLE

Combinabile con: Miss Wood sedia - pag. 70
 Combinable with: Miss Wood chair - pag. 70



Naturale, conviviale. Il tavolo che accompagna la sedia Miss ne mantiene le prerogative tecnico-estetiche. In legno massello, di faggio naturalmente venato, è sostenuto da sinuose e robuste gambe a sezione ellittica. L'innovazione strutturale è nel rapporto tra spessore del piano (di soli 3 cm) e la sua superficie (oltre 2mq). Realizzato con processi altamente tecnologici è, al pari della sedia, rifinito a mano, perfettamente levigato e tinto di sfumature. Versione sfumata, a scelta 6 delicati toni iconici; versione tinta unita, toni antracite. Disponibile in più dimensioni.

Natural, convivial. The table that accompanies the Miss chair maintains the same technical-aesthetic prerogatives. In natural beech grain solid wood, the top is supported by sinuous and sturdy legs with an elliptical profile. The structural innovation is in the relationship between the thickness of the top (only 3 cm) and the surface (over 2 square meters). Made with highly technological processes it is, like the chair, hand finished, perfectly smoothed and tinted. The gradient version is produced in a choice of 6 delicate iconic tones; the solid version in anthracite. Available in multiple sizes.



ANTRACITE SFUMATO SHADED 861



ANTRACITE 86

MISS WOOD

TAVOLO TABLE

design by
FELICE RAGAZZO
 Made in Italy

Materiali - Materials

Struttura: legno massello di faggio lavorato a CNC, con giunzioni organiche. Verniciatura a liquido realizzata a mano con aerografo, in versione tinta unita o sfumata
 Oltre i 200 cm di lunghezza, sottostruttura del piano in acciaio, integrata
 Piedini: in lana ad alta densità, antiscivolo e antigraffio



INDOOR

*Structure: solid beech wood, CNC machined, with biomimetic joints. Liquid painted by hand with airbrush in solid or shaded colour
 Over 200 cm length, integrated steel substructure of the table top
 Feet: anti-slip and non-scratch high-density wool*

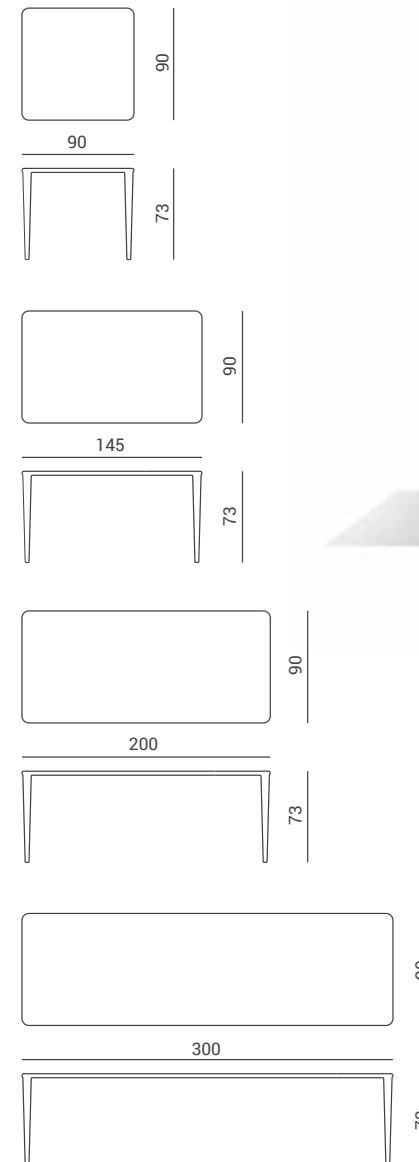

Versione Version	Peso netto Net weight	Peso con imballo Packed weight	Volume imballo Packed volume
90x90	18 kg	25 kg	0,9 m ³
145x90	25 kg	35 kg	1,4 m ³
200x90	37 kg	49 kg	1,9 m ³
300x90	65 kg	80 kg	2,8 m ³

MISS

SEDIA CHAIR

Versione in legno: Miss Wood sedia - pag. 70
 Altri prodotti della collezione Miss: Miss sgabello - pag. 72
 Wooden version: Miss Wood chair - pag. 70
 Other products from Miss collection: Miss stool pag. 72



Impilabile Stackable

MISS

SEDIA CHAIR

design by
MISSONI STUDIO
 Made in Italy

Materiali - Materials

Struttura: acciaio
 Imbottitura: poliuretano espanso indeformabile e fibra poliestere
 Piedini: gomma morbida antiscivolo e antigraffio
 Rivestimento sedile e schienale, tessuto sfoderabile, lavabile secondo le indicazioni riportate sull'etichetta
 Rivestimento gambe: tessuto non sfoderabile, lavabile con un panno umido



INDOOR



RIVESTIMENTO SFODERABILE
 REMOVABLE COVER

Structure: steel
 Padding: non-deformable polyurethane foam and polyester fiber
 Feet: non-slip and non-scratch soft rubber
 Seat and back Upholstery: removable fabric, washable according to the instructions on the label
 Leg cover: non-removable fabric, washable with a damp cloth



Design ergonomico. Di linea snella e confortevole, la sedia in struttura d'acciaio imbottita in poliuretano espanso e fibra di poliestere, ha rivestimento policromo in tessuto. Il pattern a scelta tra i tessuti d'arredamento Missoni Home Collection. Le gambe esili e rastremate aggiungono eleganza e leggerezza. Varianti con o senza braccioli. Vendute a coppie, impilabili.

Ergonomic design. The slender and comfortable line of this chair, with steel structure and padded with polyurethane foam and polyester fiber, can be upholstered in fabrics from the Missoni Home Collection, taking extreme care to position the chosen design to correct effect. The slender, tapered leg gives an elegance and lightness. Stackable and sold in pairs.

SEDIA CON BRACCIOLI
 CHAIR WITH ARMS

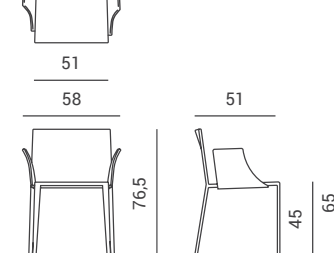

SEDIA SENZA BRACCIOLI
 CHAIR WITHOUT ARMS

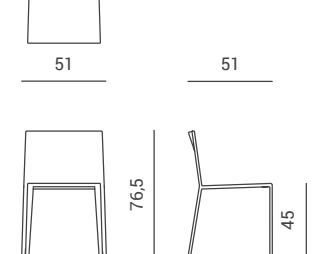

Senza braccioli
Peso netto 5,5 kg
Peso con imballo (1 sedia) 9 kg
Peso con imballo (2 sedie) 14,5 kg
Volume imballo 0,35 m³
Portata massima 120 kg

Without arms
Net weight 5,5 kg
Packed weight (1 chair) 9 kg
Packed weight (2 chairs) 14,5 kg
Packed volume 0,35 m³
Maximum load 120 kg

Con braccioli
Peso netto 8 kg
Peso con imballo (1 sedia) 11,5 kg
Peso con imballo (2 sedie) 19,5 kg
Volume imballo 0,35 m³
Portata massima 120 kg

With arms
Net weight 8 kg
Packed weight (1 chair) 11,5 kg
Packed weight (2 chairs) 19,5 kg
Packed volume 0,35 m³
Maximum load 120 kg

MISS WOOD

SEDIA CHAIR

Combinabile con: Miss Wood tavolo - pag. 66
Versione in tessuto: Miss sedia - pag. 68

Combinable with: Miss Wood table - pag. 66
Fabric version: Miss chair - pag. 68



Sintesi dell'eleganza. La perfezione della tecnica definisce il legno massello, plasmando le geometrie del tessuto. All'agile eleganza della scultura corrisponde una leggerezza robusta, risultato di un profondo studio del rapporto fra equilibrio e resistenza. Prerogativa straordinaria è l'assenza di spigoli nelle giunzioni del corpo, innovazione che conferisce alla struttura la plasticità di una giunzione organica. Realizzata con processi ad alta tecnologia, è rifinita a mano, levigata e dipinta in delicate sfumature. Versione sfumata, a scelta 6 delicati toni iconici; versione tinta unita, in tono antracite.

An elegant synthesis. The perfection of the technique defines the solid wood and shapes the geometries of the material. The agile elegance of the sculpture is matched by a robust lightness and is a result of a profound study of the relationship between balance and resistance. An extraordinary feature is the absence of edges, an innovation that gives the structure the pliancy of an organic joining. Made with high-tech processes, it is finished by hand, smoothed and painted in delicate shades. The gradient version is produced in a choice of 6 delicate iconic tones; the solid version in anthracite.

MISS WOOD

SEDIA CHAIR

design by
MISSONI STUDIO
Made in Italy



INDOOR

Materiali - Materials

Struttura: legno massello di faggio lavorato a CNC, con giunzioni organiche. Verniciatura a liquido realizzata a mano con aerografo, in versione tinta unita o sfumata

Piedini: in lana ad alta densità, antiscivolo e antigraffio

Structure: solid beech wood, CNC machined, with biomimetic joints. Liquid painted by hand with airbrush in solid or shaded colour

Feet: anti-slip and non-scratch high-density wool



Impilabile Stackable



ARANCIO
SFUMATO
SHADED 591



GIALLO
SFUMATO
SHADED 531



ROSA
SFUMATO
SHADED 251



AZZURRO
SFUMATO
SHADED 211



ANTRACITE
SFUMATO
SHADED 861



TURCHESE
SFUMATO
SHADED 701



ANTRACITE 86

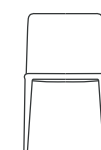

Peso netto
Peso con imballo
Volume imballo
Portata massima

Net weight
Packed weight
Packed volume
Maximum load

5,5 kg
9 kg
0,3 m³
120 kg

MISS

SGABELLO STOOL

Altri prodotti della collezione Miss:
Miss sedia - pag. 68

Other products from Miss collection:
Miss chair - pag. 68



Impilabile chic. Slanciato e accogliente lo sgabello ha sottile struttura in metallo imbottita in poliuretano espanso e fibra di poliestere. Le gambe rastremate sottolineano l'eleganza della seduta. Il rivestimento a scelta tra i tessuti d'arredamento Missoni Home Collection è posizionato con cura. Sgabelli impilabili, venduti a coppie, disponibili in 2 altezze e con barra poggia piedi in metallo o rivestita.

Stackable chic. Slender and welcoming, the stool has a thin metal structure and padded with polyurethane and polyester fiber. The tapered legs emphasize the elegance. Upholstery to be chosen from furnishing fabrics in the Missoni Home Collection, with careful attention to the design positioning. Stackable, sold in pairs and available in 2 heights and with metal or fabric-covered footrest bar.



Impilabile Stackable

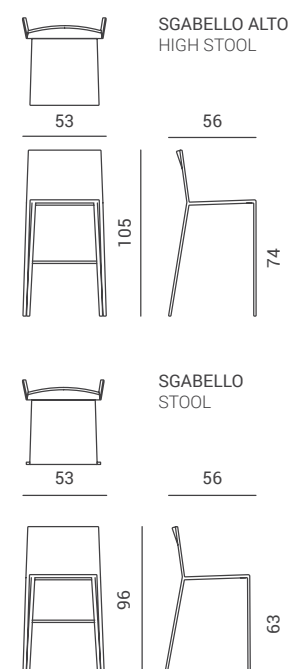

MISS

SGABELLO STOOL

design by
MISSONI STUDIO
Made in Italy

Materiali - Materials

Struttura: acciaio

Imbottitura: poliuretano espanso indeformabile e fibra poliestere

Piedini: gomma morbida antiscivolo e antigraffio

Rivestimento sedile e schienale, tessuto sfoderabile, lavabile secondo le indicazioni riportate sull'etichetta

Rivestimento gambe: tessuto non sfoderabile, lavabile con un panno umido

Barra poggia piedi, disponibile nella versione in metallo o rivestita in tessuto non sfoderabile



INDOOR



RIVESTIMENTO SFODERABILE
REMOVABLE COVER

Structure: steel

Padding: non-deformable polyurethane foam and polyester fiber

Feet: anti-slip and non-scratch soft rubber

Seat and back Upholstery: removable fabric, washable according to the instructions on the label

Leg cover: non-removable fabric, washable with a damp cloth

Footrest bar, available in metal version or covered in non-removable fabric



Versione bassa
Peso netto
Peso con imballo (1 sedia)
Peso con imballo (2 sedie)
Volume imballo
Portata massima

Version low
Net weight
Packed weight (1 chair)
Packed weight (2 chairs)
Packed volume
Maximum load

7,5 kg
11 kg
18,5 kg
0,65 m³
120 kg

Versione alta
Peso netto
Peso con imballo (1 sedia)
Peso con imballo (2 sedie)
Volume imballo
Portata massima

Version high
Net weight
Packed weight (1 chair)
Packed weight (2 chairs)
Packed volume
Maximum load

8 kg
11,5 kg
19 kg
0,65 m³
120 kg

BEDROOM



ADAR

LETTO BED

Altri prodotti della collezione Adar:
pag. 10 Adar divano

Other products from Adar collection:
pag. 10 Adar sofa



Essenziale, personalizzabile. Base in metallo e testiera morbida composta da 2 elementi - cuscini indipendenti e sfilabili. Il pattern del tessuto Missoni Home Collection che riveste testiera e giroletto imbottiti è a scelta tra le proposte in collezione. Disponibile in varie dimensioni, è completo di supporti poggia-rete.

Essential, customisable. Metal base with a soft headboard comprised of two independent and removable cushion elements. The headboard and base frame can be upholstered in fabrics from the Missoni Home Collection. Available in various sizes, the bed is complete with slats frame supports (slats frame sold separately).

ADAR

LETTO BED

design by
MISSONI STUDIO
Made in Italy

Materiali - Materials

Base: telaio in acciaio verniciato a polvere in colore Charcoal

Piedini: in materiale plastico e lana ad alta densità, antiscivolo e antigraffio

Struttura del giroletto: legno multistrato con giunzioni e supporto rete in acciaio

Imbottitura: poliuretano espanso indeformabile, rivestito di ovatta in fibra di poliestere

Rivestimento: tessuto sfoderabile, lavabile secondo le indicazioni riportate sull'etichetta

Sistema di aggancio della testiera: perni in metallo inseriti a baionetta nelle sedi del giroletto

Rete e materasso - Slats frame and mattress

Supporti poggia-rete regolabili a 5 altezze.
Rete e materasso disponibili su richiesta



INDOOR



RIVESTIMENTO SFODERABILE
REMOVABLE COVER

Base: steel frame, powder coated in charcoal colour
Feet: non-slip and non-scratch soft rubber
Bed frame structure: plywood with steel joints and slats frame supports
Padding: non-deformable polyurethane foam covered with polyester fiber wadding
Upholstery: removable Cover: washable according to the instructions on the label
Headboard attachment system: metal bayonet pins inserted in frame of bed

Slats frame supports adjustable to 5 heights.
Slats frame and mattress available on request

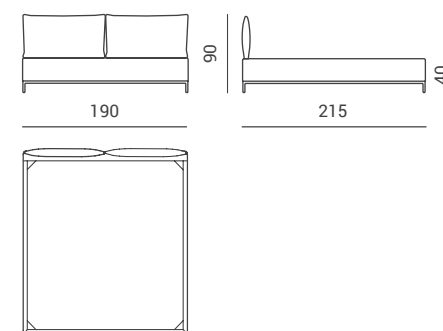

Le misure del letto variano in funzione del materasso richiesto. Esempio per materasso da 180x200 cm
Size of the bed vary according to the mattress required.
Example for a 180x200 cm mattress

Peso - Weight

Il peso del letto varia in funzione del materasso richiesto. Esempio per materasso da 180x200 cm

Peso netto	Net weight	75 kg
Peso con imballo	Packed weight	80 kg
Volume imballo	Packed volume	0,8 m³

Weight of the bed vary according to the mattress required.
Example for a 180x200 cm mattress

INNTIL

LETTO BED

Altri prodotti della collezione Inntil: pag. 14 - 16

Other products from Inntil collection: pag. 14 - 16



Design e relax. Il letto di linea ben modellata ha una struttura in legno ricoperta di materiale indeformabile e rivestita in tessuto. La prerogativa è il lungo cuscino-poggiatesta a incastro che funge da testiera. Il pattern tessile per vestire entrambi gli elementi sfoderabili è a scelta tra le proposte Missoni Home Collection. In varie misure e fornito con supporti poggia-rete.

Design and relax. This well-designed bed has a wooden structure: covered in a non-deformable padding and upholstery fabric. The main design feature is the long back cushion that acts as a headboard. Upholstery to be chosen from fabrics in the Missoni Home Collection. Available in various sizes and supplied with slats frame supports (slats frame sold separately).

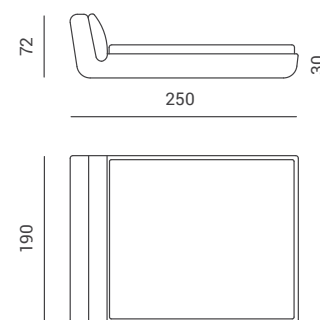

Le misure del letto variano in funzione del materasso richiesto. Esempio per materasso da 180x200 cm
Size of the bed vary according to the mattress required.
Example for a 180x200 cm mattress

INNTIL

LETTO BED

design by
MISSONI STUDIO
Made in Italy

Materiali - Materials

Struttura del giroletto: legno multistrato con giunzioni e supporto rete in acciaio

Imbottitura: poliuretano espanso indeformabile, rivestito di ovatta in fibra di poliestere

Rivestimento: tessuto sfoderabile, lavabile secondo le indicazioni riportate sull'etichetta

Piedini: gomma morbida antiscivolo e antigraffio

Rete e materasso - Slats frame and mattress

Supporti poggia-rete regolabili a 5 altezze.
Rete e materasso disponibili su richiesta



INDOOR



RIVESTIMENTO SFODERABILE
REMOVABLE COVER

Bed frame structure: plywood with steel joints and slats frame supports

Padding: non-deformable polyurethane foam covered with polyester fiber wadding

Upholstery: removable fabric, washable according to the instructions on the label

Feet: anti-slip and non-scratch soft rubber

*Slats frame supports adjustable to 5 heights.
Slats frame and mattress available on request*

Peso - Weight

Il peso del letto varia in funzione del materasso richiesto. Esempio per materasso da 180x220 cm

Peso netto	Net weight	75 kg
Peso con imballo	Packed weight	80 kg
Volume imballo	Packed volume	3,5 m³

*Weight of the bed vary according to the mattress required.
Example for a 180x220 cm mattress*

MORFEO

LETTO BED



Semplice, essenziale. Di stile volutamente rigoroso e minimale, il letto appena ammorbidito dall'imbottitura punta sull'unicità del tessuto e del pattern di Rivestimento: variabile nelle geometrie e nei disegni. Da selezionare tra le proposte Missoni Home Collection. In diverse misure, fornito di supporti poggia-rete.

Simple, essential. A purposely rigorous and minimal style, the design is just softened by the padding and the uniqueness of the fabric for the covering. The upholstery to be chosen from furnishing fabrics in the Missoni Home Collection. Available in different sizes and delivered with slats frame supports.

MORFEO

LETTO BED

design by
MISSONI STUDIO
Made in Italy

Materiali - Materials

Struttura del giroletto: legno multistrato con giunzioni e supporto rete in acciaio

Imbottitura: poliuretano espanso indeformabile, rivestito di ovatta in fibra di poliestere

Rivestimento: tessuto sfoderabile, lavabile secondo le indicazioni riportate sull'etichetta

Piedini: gomma morbida antiscivolo e antigraffio

Rete e materasso - Slats frame and mattress

Supporti poggia-rete regolabili a 5 altezze.
Rete e materasso disponibili su richiesta



INDOOR



RIVESTIMENTO SFODERABILE
REMOVABLE COVER

Bed frame structure: plywood with steel joints and slats frame supports

Padding: non-deformable polyurethane foam covered with polyester fiber wadding

Upholstery: removable fabric, washable according to the instructions on the label

Feet: anti-slip and non-scratch soft rubber

*Slats frame supports adjustable to 5 heights.
Slats frame and mattress available on request*

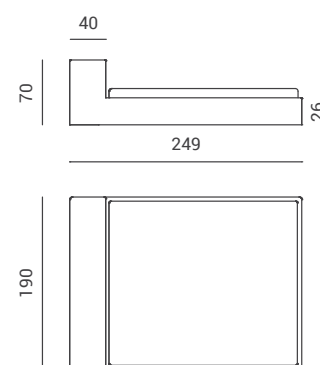

Le misure del letto variano in funzione del materasso richiesto. Esempio per materasso da 180x200 cm
*Size of the bed vary according to the mattress required.
Example for a 180x200 cm mattress*

Peso - Weight

Il peso del letto varia in funzione del materasso richiesto. Esempio per materasso da 180x220 cm

Peso netto	<i>Net weight</i>	80 kg
Peso con imballo	<i>Packed weight</i>	88 kg
Volume imballo	<i>Packed volume</i>	2 m³

*Weight of the bed vary according to the mattress required.
Example for a 180x220 cm mattress*

ONIRO

LETTO BED

ONIRO

LETTO BED

design by
MISSONI STUDIO
Made in Italy



INDOOR



RIVESTIMENTO SFODERABILE
REMOVABLE COVER

Materiali - Materials

Struttura: multistrato di abete e acciaio
Imbottitura: poliuretano ad alta densità a quote differenziate
Rivestimento: tessuto sfoderabile, lavabile secondo le indicazioni riportate sull'etichetta
Piedini: in plastica antiscivolo con punto al suolo in gomma e feltrini in lana ad alta densità

*Structure: fir multi-layered wood and steel
Padding: high density polyurethane foam in varied densities
Upholstery: removable fabric, washable according to the instructions on the label
Feet: anti-scratch with rub and high density wool*

Rete e materasso - Slats frame and mattress

Supporti poggia-rete regolabili a 5 altezze.
Rete e materasso disponibili su richiesta

*Slats frame supports adjustable to 5 heights.
Slats frame and mattress available on request*

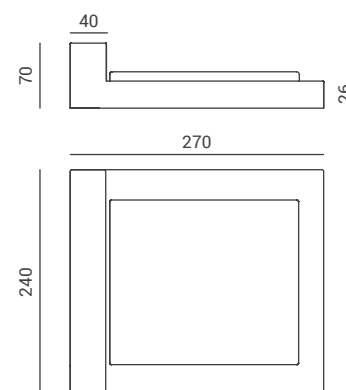

Dettagli essenziali. Di stile volutamente semplice e minimale, il letto appena ammorbidito dall'imbottitura punta sull'unicità del pattern di rivestimento. Dettaglio innovativo è il disegno della base sporgente che lo contorna creando un funzionale punto di appoggio. Cover da realizzare in qualsiasi tessuto a scelta della Missoni Home Collection. In diverse misure. Fornito di supporti poggia-rete.

Essential details. Of an intentional simple and minimal style, the bed barely softened by the padding relies on the uniqueness of the pattern of the cover. An innovative detail is the design of the protruding base that surrounds it creating a functional support. Cover to be made in any fabric of choice from the Missoni Home Collection. In various sizes. Provided with bedspring supports.

Le misure del letto variano in funzione del materasso richiesto. Esempio per materasso da 180x200 cm
*Size of the bed vary according to the mattress required.
Example for a 180x200 cm mattress*

Peso - Weight

Il peso del letto varia in funzione del materasso richiesto. Esempio per materasso da 180x220 cm

*Weight of the bed vary according to the mattress required.
Example for a 180x220 cm mattress*

Peso netto	<i>Net weight</i>	120 kg
Peso con imballo	<i>Packed weight</i>	130 kg
Volume imballo	<i>Packed volume</i>	0,79 m³

SCREEN

LETTO BED



Rifugio schermato. L'importanza della testiera design che supporta, avvolge e scherma il letto, è il punto focale e l'elemento variabile del progetto. Struttura e giroletto in legno imbottito sono ricoperti in tessuto a scelta di Missoni Home Collection. Il rivestimento è posizionato con cura nel rispetto dei pattern. Testiera in diverse proporzioni e in versione con/senza ante. Letto in diverse misure, con supporti poggia-rete.

A place to retreat. The importance of the headboard is that it supports, wraps and screens the bed, it is the focal point of the design. The structure and wood bed frame are upholstered in fabric chosen from the Missoni Home Collection and carefully positioned to respect the pattern of the fabric. The headboard is available in different proportions, with or without the panel. Bed available in different sizes, with slats frame supports.

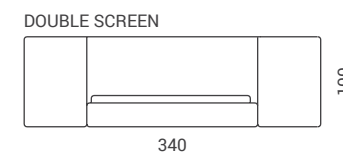
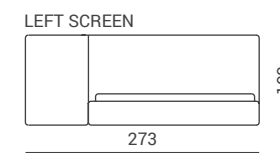
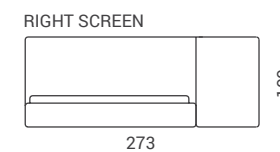
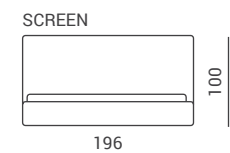
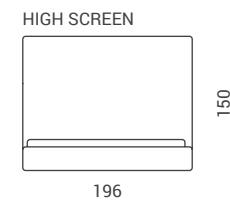
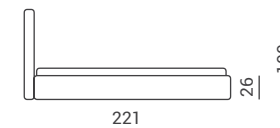
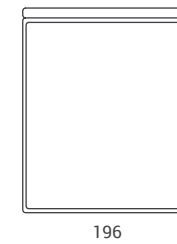

Le misure del letto variano in funzione del materasso richiesto. Esempio per materasso da 180x200 cm
Size of the bed vary according to the mattress required. Example for a 180x200 cm mattress

SCREEN

LETTO BED

design by
MISSONI STUDIO
 Made in Italy

Materiali - Materials

Struttura del giroletto: legno multistrato con giunzioni e supporto rete in acciaio

Imbottitura: poliuretano espanso indeformabile, rivestito di ovatta in fibra di poliestere

Rivestimento: tessuto sfoderabile, lavabile secondo le indicazioni riportate sull'etichetta

Piedini: gomma morbida antiscivolo e antigraffio

Rete e materasso - Slats frame and mattress

Supporti poggia-rete regolabili a 5 altezze. Rete e materasso disponibili su richiesta



INDOOR



RIVESTIMENTO SFODERABILE
 REMOVABLE COVER

Bed frame structure: plywood with steel joints and slats frame supports

Padding: non-deformable polyurethane foam covered with polyester fiber wadding

Upholstery: removable fabric, washable according to the instructions on the label

Feet: anti-slip and non-scratch soft rubber

Slats frame supports adjustable to 5 heights. Slats frame and mattress available on request



Peso - Weight

Il peso del letto varia in funzione del materasso richiesto. Esempio per materasso da 180x200 cm

Weight of the bed vary according to the mattress required. Example for a 180x200 cm mattress

Versione Version	Peso netto Net weight	Peso con imballo Packed weight	Volume imballo Packed volume
High High	75 kg	80 kg	3,5 m ³
Senza ante Without side panels	70 kg	80 kg	2,4 m ³
Con 1 ante With 1 side panel	70 kg	80 kg	2,5 m ³
Con 2 ante With 2 side panels	80 kg	90 kg	2,7 m ³

LEVANTE

PARAVENTO SCREEN



Stile e fantasia. Il paravento è composto da ante indipendenti, collegate da magneti. Questo sistema consente di aggiungere, spostare, rimuovere gli elementi in modo facile. Il rivestimento può essere double-face, da realizzare a scelta con due diversi tessuti d'arredamento Missoni Home Collection. Completamente sfoderabile. Disponibile in 2 misure.

Style and fantasy. This screen is made up of independent panels that are connected by magnets. The system makes it easy to add, move or remove elements. The upholstery can be chosen from furnishing fabrics in the Missoni Home Collection, can also be double-sided if required, and is removable. Available in 2 sizes.



Dettaglio *Detail*

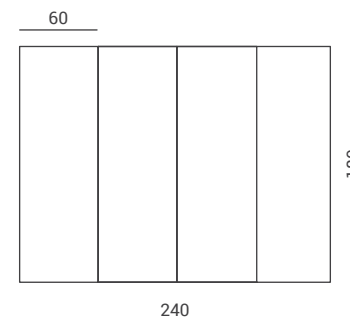
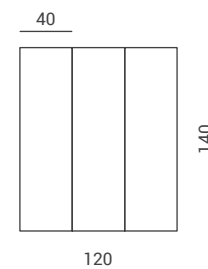

LEVANTE

PARAVENTO SCREEN

design by
MISSONI STUDIO
Made in Italy

Materiali - Materials

Struttura: legno multistrato

Imbottitura: poliuretano espanso, rivestito di ovatta in fibra di poliestere

Rivestimento: tessuto sfoderabile, lavabile secondo le indicazioni riportate sull'etichetta

Piedini: in feltro antiscivolo e antigraffio

Sistema di aggancio fra le ante; magneti al neodimio integrati nella struttura



INDOOR



RIVESTIMENTO SFODERABILE
REMOVABLE COVER

Structure: plywood

Padding: polyurethane foam covered with polyester fiber wadding

Upholstery: removable fabric, washable according to the instructions on the label

Feet: anti-slip and non-scratch felt

Linking system for the panels: neodymium magnets integrated in the structure



Versione alta 4 ante *High version 4 panels*
Peso netto *Net weight* **21 kg**
Peso con imballo *Packed weight* **23 kg**
Volume imballo *Packed volume* **0,1 m³**

Versione bassa 3 ante *Low version 3 panels*
Peso netto *Net weight* **10,5 kg**
Peso con imballo *Packed weight* **12,5 kg**
Volume imballo *Packed volume* **0,05 m³**

PONENTE

PARAVENTO SCREEN



Coreografia e stile. Il paravento decorativo è composto da tre pannelli, collegati da cerniere in acciaio. La struttura, esclusivamente da indoor, si può foderare in qualsiasi tessuto della collezione. Nella scelta del rivestimento per uno speciale effetto double-face si può optare per una coppia di tessuti da selezionare tra le proposte della Home. Disponibile nelle due dimensioni h140 e h180 cm. Non sfoderabile.

Choreography and style. The decorative screen is made up of three panels, connected by steel hinges. The structure, exclusively for indoors, can be covered in any fabric of the collection. In the choice of covering for a special reversible effect, it is possible to choose a pair of fabrics from the Home selection. Available in two sizes H 140 and H 180 cm. Not removable.



Dettaglio *Detail*

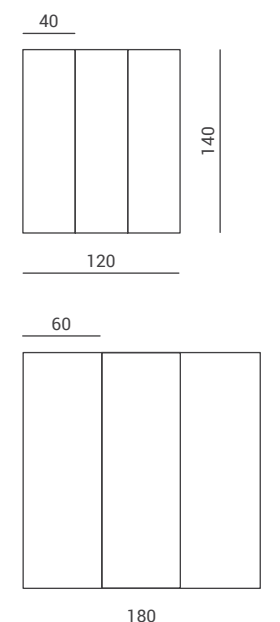

PONENTE

PARAVENTO SCREEN

design by
MISSONI STUDIO
Made in Italy

Materiali - Materials

Struttura: multistrato di abete
Imbottitura: ovatta di poliestere
Rivestimento: tessuti della collezione
Piedini: in lana ad alta densità
Sistema di aggancio fra le ante: cerniere in acciaio



INDOOR

*Structure: fir multi-layered wood
Padding: polyester fiberfill
Upholstery: collection's fabrics
Feet: high density wool
Linking system for the panels: steel hinge*



Versione alta	High version		Versione bassa	Low version	
Peso netto	Net weight	16 kg	Peso netto	Net weight	10,5 kg
Peso con imballo	Packed weight	18 kg	Peso con imballo	Packed weight	12,5 kg
Volume imballo	Packed volume	0,09 m³	Volume imballo	Packed volume	0,05 m³

OUTDOOR



NAP OUTDOOR

DIVANO MODULARE MODULAR SOFA

Versione indoor: pag. 18

Indoor version: pag. 18



Componibile, da esterni. La geometria essenziale del divano con moduli diversi e collegati da agganci a scomparsa, dà risalto al pattern del tessuto. Il rivestimento da outdoor, idrorepellente e antimacchia è a scelta tra le proposte Missoni Home Collection. Parte inferiore traspirante e piedini rialzati per uso in ambiente esterno. Optional, il cuscino Saponetta per maggior comfort.

Modular, for outdoors. The geometry of this clean-lined sofa, composed of different modules, is connected with retractable hooks. The simple shape gives space for the fabric to be the focus. Upholstery to be chosen from outdoor, water-repellent and stain-resistant fabrics in the Missoni Home collection. For outdoor use, the base is breathable, with feet to raise the sofa off the ground. For greater comfort, there is the option to include a back cushion "Saponetta".

CUSCINO SCHIENALE BACK CUSHION

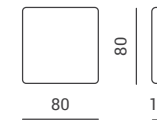

ELEMENTO DIVANO 3P 3PC SOFA MODULE

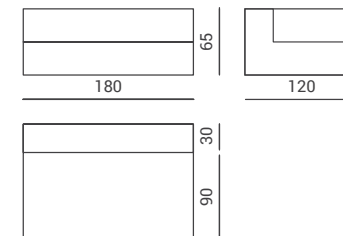

BRACCIOLO ARMREST

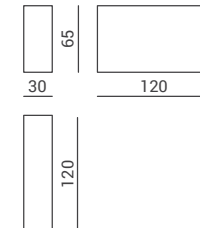

CHAISE LONGUE

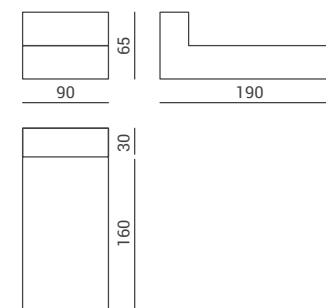

POUF POUF

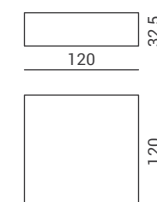

NAP OUTDOOR

DIVANO MODULARE MODULAR SOFA

design by
MISSONI STUDIO
Made in Italy

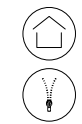

OUTDOOR



RIVESTIMENTO SFODERABILE
REMOVABLE COVER

Materiali - Materials

Struttura: legno multistrato marino con sospensione su cinghie elastiche

Imbottitura: poliuretano a celle aperte a quote differenziate, rivestito con fibra di poliestere spaziatto

Rivestimento: tessuto per esterno sfoderabile, lavabile secondo le indicazioni riportate sull'etichetta

Sistema di aggancio fra moduli: ad incastro rapido, predisposti in base alla composizione scelta

Piedini: plastica antiscivolo e antigraffio

Structure: marine plywood with elastic wadding suspension

Padding: open-cell polyurethane in different densities, covered with spaced polyester fibre

Upholstery: removable outdoor fabric, washable according to the instructions on the label

Coupling system between modules: quick-interlock, arranged according to the chosen composition

Feet: anti-slip and non-scratch plastic

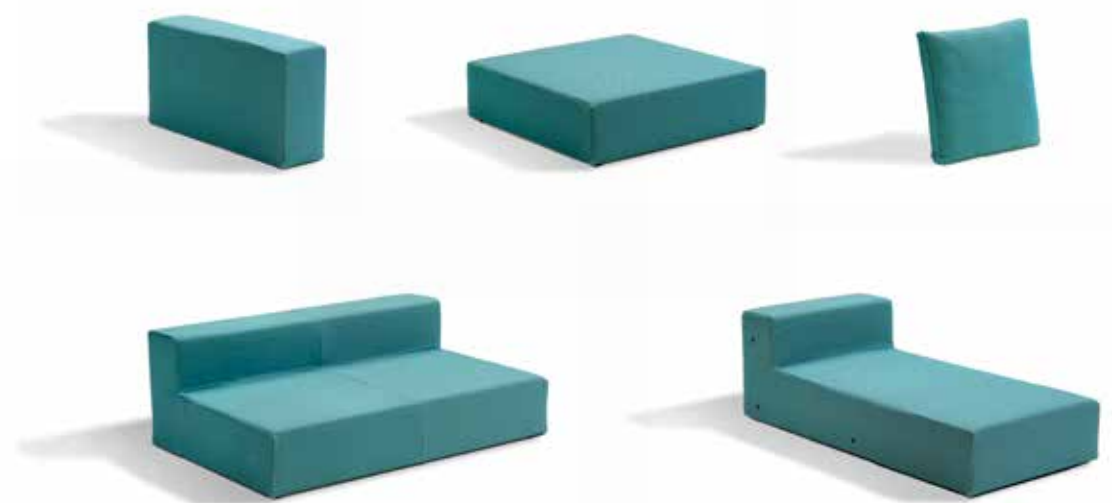

Modulo Unit	Peso netto Net weight	Peso con imballo Packed weight	Volume imballo Packed volume
Cuscino schienale Back cushion	2 kg	2 kg	0,09 m ³
Divano 3 posti Sofa 3 seat	57 kg	66 kg	1,75 m ³
Bracciolo Arm	15 kg	19 kg	0,35 m ³
Chaise longue Chaise longue	47 kg	54 kg	1,4 m ³
Pouf Pouf	21 kg	25 kg	0,65 m ³
Portata massima per modulo Maximum load per module		120 kg	

CORDULA CUOIO

POLTRONA ROTONDA ROUND CHAIR

Versione in corda: pag. 30
 Altri prodotti della collezione Cordula Cuoio:
 pag. 44 - 46 - 96
 Cord version: pag. 30
 Other products from Cordula Cuoio collection:
 pag. 44 - 46 - 96



Essenziale, elegante, ariosa. La poltrona tonda con schienale a ventaglio prende forma da 3 anelli di acciaio incurvato sovrapposti e intelaiati da corde di cuoio chiaro annodate a mano. La struttura design ha una finitura spazzolata in tono con il rivestimento. Esclusivamente da interni.

Essential, elegant, airy. The round armchair, with fan-shaped back, takes shape from 3 overlapping curved steel rings and framed by hand-knotted leather cord. The structure has a brushed finish in the same tone as the leather cord. For indoor use only.

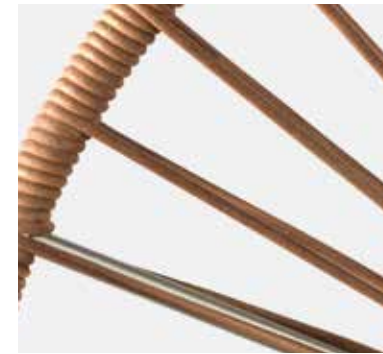

Dettaglio Detail

CORDULA CUOIO

POLTRONA ROTONDA ROUND CHAIR

design by
MISSONI STUDIO
 Made in Italy

Materiali - Materials

Struttura: tondino in acciaio inox curvato, finitura spazzolata, verniciata in abbinamento alla corda
 Rivestimento: corda in cuoio
 Piedini: in gomma antiscivolo e antigraffio



INDOOR

*Structure: curved stainless steel rod, brushed finish, painted in combination with the cord colour
 Covering: leather cord
 Feet: non-slip and non-scratch rubber*

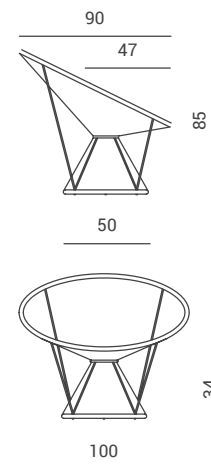

Peso netto	<i>Net weight</i>	10 kg
Peso con imballo	<i>Packed weight</i>	14 kg
Volume imballo	<i>Packed volume</i>	0,87 m³
Portata massima	<i>Maximum load</i>	100 kg

CORDULA CUOIO

POLTRONCINA E POGGIPIEDI ARMCHAIR AND FOOTSTOOL

Versione in corda: pag. 32
 Altri prodotti della collezione Cordula Cuoio:
 pag. 44 - 46 - 94
 Cord version: pag. 32
 Other products from Cordula Cuoio collection:
 pag. 44 - 46 - 94



Esclusività e stile. La poltroncina con poggiatesta ha una struttura geometrica in acciaio curvato e una preziosa intelaiatura di stringhe in cuoio annodate a mano per un corretto supporto anatomico. Per arredo d'interni. Elementi in vendita anche singolarmente.

Exclusivity and style. In curved steel, this armchair with footrest has a geometric structure and is framed by hand-knotted leather cord for correct anatomical support. For indoor use only. Each item can be purchased individually.

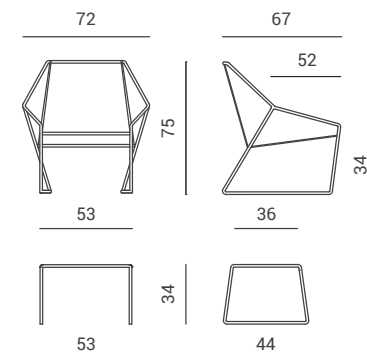

CORDULA CUOIO

POLTRONCINA E POGGIPIEDI ARMCHAIR AND FOOTSTOOL

design by
MISSONI STUDIO
 Made in Italy



Materiali - Materials

Struttura: tondino in acciaio inox curvato, finitura spazzolata, verniciata in abbinamento alla corda
 Rivestimento: corda in cuoio
 Piedini: in materiale plastico, antiscivolo e antigraffio

Structure: hand-curved stainless steel rod, brushed finish
 Covering: PET HT rope with multicolor chevron motif
 Feet: anti-slip and non-scratch plastic

Dettaglio Detail



Poltroncina	Armchair		Poggiapiedi	Footstool	
Peso netto	Net weight	8 kg	Peso netto	Net weight	6,7 kg
Peso con imballo	Packed weight	12 kg	Peso con imballo	Packed weight	8 kg
Volume imballo	Packed volume	0,4 m ³	Volume imballo	Packed volume	0,1 m ³
Portata massima	Maximum load	100 kg	Portata massima	Maximum load	100 kg

VIRGOLA SOFT

SEDUTA SEATING

Versione indoor: Virgola - pag. 38

Indoor version: Virgola - pag. 38



VIRGOLA SOFT

SEDUTA SEATING

design by
MISSONI STUDIO
Made in Italy

Materiali - Materials

Struttura: microsfere di polipropilene e fibra di poliestere
Rivestimento: sfoderabile, in tessuto idrorepellente e antimacchia



INDOOR



OUTDOOR



RIVESTIMENTO SFODERABILE
REMOVABLE COVER

Structure: polypropylene microbeads and polyester fibre
Cover: removable, in water repellent and stain proof fabric



New shape, indoor/outdoor. La versione Soft di Virgola offre isole relax attraenti e paffute, estremamente accoglienti e resilienti. La nuova modellatura è stata progettata per aumentare il comfort e garantire la doppia performance outdoor/indoor. Protetta da rivestimenti in canvas waterproof la seduta ha finiture molto accurate e resistenti. L'imbottitura a microsfere di polipropilene offre una compattezza invitante, morbida, graduata.

New shape, indoor/outdoor. The Soft version of the Virgola is an attractive and plump relaxation island, extremely welcoming and resilient. The new shaping has been designed to increase comfort and guarantee double performance for outdoor/indoor. Protected by waterproof canvas covers, the seat has a very high-tech and resistant finish. The polypropylene microsphere padding offers an inviting, soft and graduated compactness.

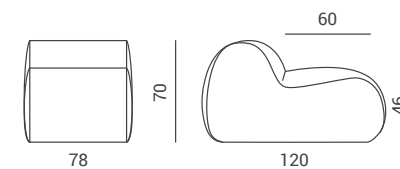

Peso netto	Net weight	10 kg
Peso con imballo	Packed weight	13 kg
Volume imballo	Packed volume	0,7 m³
Portata massima	Maximum load	120 kg

JALAMAR OUTDOOR

CHAISE LONGUE LOUNGER

Versione indoor: pag. 40

Indoor version: pag. 40

JALAMAR OUTDOOR

CHAISE LONGUE LOUNGER

design by
CRISTIANO MAGNONI
Made in Italy

Materiali - Materials

Struttura: in acciaio con meccanismi a scatto da 5 posizioni per lo schienale e 3 posizioni per le gambe

Imbottitura: poliuretano espanso indeformabile, rivestito di ovatta in fibra di poliestere

Rivestimento: tessuto sfoderabile idrorepellente e antimacchia, lavabile secondo le indicazioni riportate sull'etichetta

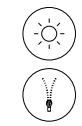

OUTDOOR



RIVESTIMENTO SFODERABILE
REMOVABLE COVER

Structure: in steel with 5-position adjustable mechanism for the backrest and 3-position for the leg rest

Padding: non-deformable polyurethane foam covered with polyester fiber wadding

Upholstery: removable fabric, water repellent and stain resistant, washable according to the instructions on the label

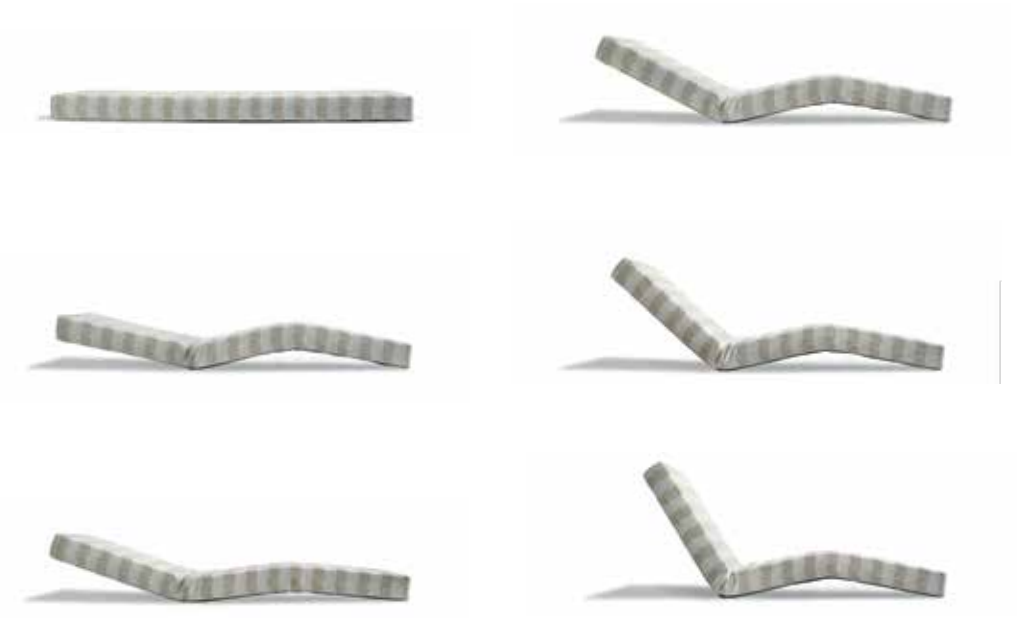

Comfort outdoor. La chaise longue anatomica da esterni è un elemento confortevole e decorativo. Il materassino azionato da meccanismi interni assume diverse inclinazioni, 5 per lo schienale, 3 per il poggiatesta. Rivestimento a scelta tra i tessuti Missoni Home Collection. La parte inferiore del cover è idrorepellente, antimuffa e antimacchia, per l'appoggio a terra.

Outdoor comfort. This chaise longue offers anatomical comfort and a decorative aesthetic. The mattress is operated by an internal mechanism that adjusts inclinations, 5 positions for the backrest and 3 for the leg-rest. Upholstery to be chosen from outdoor fabrics from the Missoni Home Collection. As it is positioned directly on the floor, the base is made from water-repellent, anti-mould and anti-stain fabric.

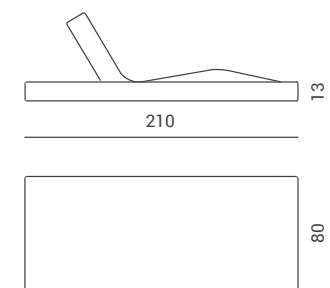

Peso netto	Net weight	20 kg
Peso con imballo	Packed weight	24 kg
Volume imballo	Packed volume	0,3 m³
Portata massima	Maximum load	100 kg

HARRY GLASS OUTDOOR

TAVOLINO LOW TABLE

Versione indoor: pag. 52

Indoor version: pag. 52



Multiuso, in&outdoor. Nelle due versioni quadrata/rettangolare i tavolini da esterni hanno il piano di vetro temprato, oleofobico. La stampa del motivo chevron opalescente con effetto 3D è realizzata con inchiostri ceramici per garanzia di lunga durata. La struttura in acciaio del supporto, progettata per resistere alle intemperie, è verniciata a polvere. Disponibili in 4 misure e altezze diverse.

Multi-functional, in&outdoor. In the two versions, square/rectangular, the outdoor tables have a tempered, oleophobic glass top. The opalescent chevron motif print with 3D effect is made with ceramic inks to guarantee long life. The steel stand structure, designed to resist weather elements, is powder-coated. Available in 4 different sizes and heights.



Dettaglio Detail

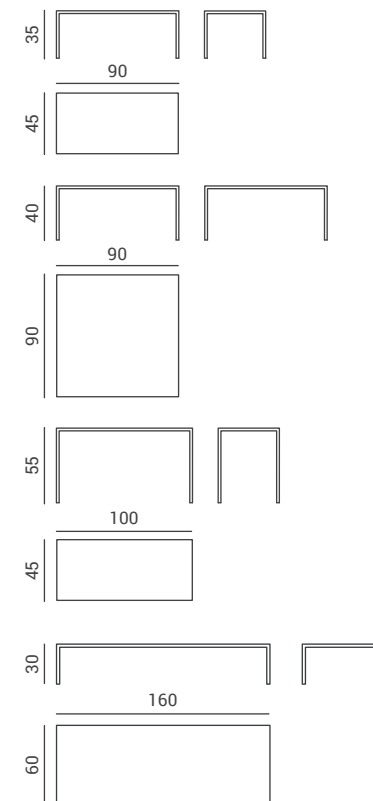

HARRY GLASS OUTDOOR

TAVOLINO LOW TABLE

design by
MISSONI STUDIO
 Made in Italy

Materiali - Materials

Base: acciaio verniciato a polvere

Piedini: in plastica antigraffio

Piano d'appoggio: in vetro temprato stampato con inchiostri ceramici



OUTDOOR

Base: powder coated steel

Feet: anti-scratch plastic

Table top: tempered glass printed with ceramic ink



Versione 90x90 cm	Version 90x90 cm	Versione 100x45 cm	Version 100x45 cm
Peso netto	Net weight	Peso netto	Net weight
28 kg		18,5 kg	
Peso con imballo	Packed weight	Peso con imballo	Packed weight
33,5 kg		24 kg	
Volume imballo	Packed volume	Volume imballo	Packed volume
0,5 m³		0,48 m³	
Versione 90x45 cm	Version 90x45 cm	Versione 160x60 cm	Version 160x60 cm
Peso netto	Net weight	Peso netto	Net weight
17 kg		34 kg	
Peso con imballo	Packed weight	Peso con imballo	Packed weight
22 kg		44 kg	
Volume imballo	Packed volume	Volume imballo	Packed volume
0,23 m³		0,48 m³	

CORDULA

SEDIA CHAIR

Altri prodotti della collezione Cordula:
pag. 30 - 32 - 106 - 122

Other products from Cordula collection:
pag. 30 - 32 - 106 - 122



Impilabile Stackable

CORDULA

SEDIA CHAIR

design by
MISSONI STUDIO
Made in Italy

Materiali - Materials

Struttura: tondino in acciaio inox curvato a mano, finitura spazzolata
Rivestimento: corda in PET HT a motivo chevron multicolor
Piedini: in materiale plastico, antiscivolo e antigraffio

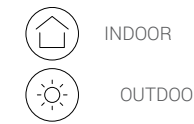

Structure: hand-curved stainless steel rod, brushed finish
Covering: PET HT rope with multicolour chevron motif
Feet: anti-slip and non-scratch plastic



Rigorosa, versatile. Sulla struttura esile e solida in acciaio curvato si annodano le corde robuste e flessibili appositamente create. La sedia essenziale con i tiranti a micro-zigzag intrecciati a mano e in materiale impermeabile ha tutte le caratteristiche ubique indoor/outdoor della serie Cordula. Impilabile.

Durable and versatile. The solid curved steel Structure: has a slender profile and is covered in a specially created knotted, flexible rope. This essential chair, with waterproof, hand-woven micro-zigzag rope is part of the Cordula series and suitable for indoor and outdoor use. Stackable.

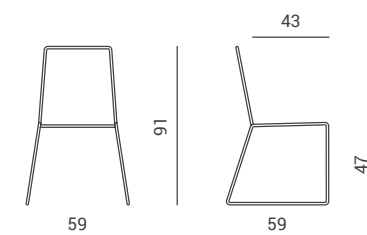

Peso netto	Net weight	8 kg
Peso con imballo	Packed weight	11,5 kg
Volume imballo	Packed volume	0,38 m³
Portata massima	Maximum load	100 kg

CORDULA

SGABELLO STOOL

Altri prodotti della collezione Cordula:
pag. 30 - 32 - 104 - 122

Other products from Cordula collection:
pag. 30 - 32 - 104 - 122



Agile, contemporaneo. La dinamica struttura in acciaio curvato sostiene la seduta con spalliera intelaiata da corde annodate a mano. L'importanza della base favorisce la stabilità dello sgabello impilabile. L'impermeabilità del materiale ne consente l'uso indoor/outdoor.

Agile, contemporary. The dynamic curved steel structure supports the seat with a back framed by hand-knotted rope. The design of the base of this stackable stool gives strong stability. The impermeability of the material allows for indoor and outdoor use.

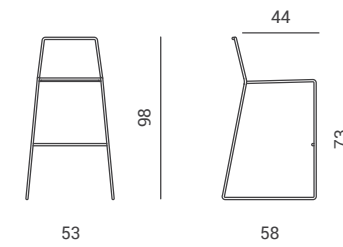

CORDULA

SGABELLO STOOL

design by
MISSONI STUDIO
Made in Italy

Materiali - Materials

Struttura: tondino in acciaio inox curvato a mano, finitura spazzolata

Rivestimento: corda in PET HT a motivo chevron multicolor

Piedini: in materiale plastico, antiscivolo e antigraffio

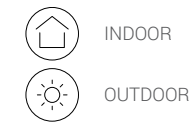

Structure: hand-curved stainless steel rod, brushed finish
Covering: PET HT rope with multicolour chevron motif
Feet: anti-slip and non-scratch plastic

Impilabile Stackable



Peso netto	Net weight	6,5 kg
Peso con imballo	Packed weight	10 kg
Volume imballo	Packed volume	0,4 m³
Portata massima	Maximum load	100 kg

REGISTA

SEDIA CHAIR



Evergreen, funzionale. Semplicità e intrinseca qualità estetica, la sedia da regista è realizzata con struttura in legno di faggio a verniciatura waterproof e ha seduta e schienale in tessuto da outdoor facilmente sfilabili. Rivestimento a scelta tra i tessuti d'arredamento Missoni Home Collection. La sedia è ripiegabile.

Evergreen, functional. Simplicity with an intrinsic aesthetic quality, this director's chair is made of beech wood with a waterproof varnish finish. The outdoor fabric of the seat and back is easily removable and can be chosen from furnishing fabrics of the Missoni Home Collection. Foldable.



BIANCO
NATURALE



FRASSINO

REGISTA

SEDIA CHAIR

design by
MISSONI STUDIO
Made in Italy

Materiali - Materials

Struttura: legno di frassino impregnato a due mani per utilizzo nautico

Sedile e schienale: tessuto per esterno removibile, lavabile secondo le indicazioni riportate sull'etichetta



INDOOR



OUTDOOR



RIVESTIMENTO SFODERABILE
REMOVABLE COVER

Structure: ash wood, double-impregnated for nautical usage

Seat and back: removable outdoor fabric, washable according to the instructions on the label

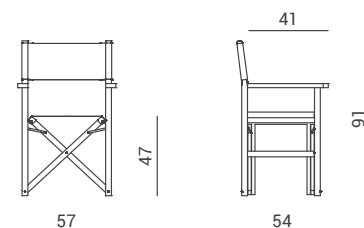

Peso netto	Net weight	6 kg
Peso con imballo	Packed weight	10 kg
Volume imballo	Packed volume	0,13 m³
Portata massima	Maximum load	100 kg

LUNA

AMACA HAMMOCK



Unicum, stile libero. Iconica e ironica l'amaca dall'animo esotico e identità timeless ha una doppia valenza, unicità decor e funzionalità relax. L'intreccio a mano, artistico e policromo di fili ritorti a tre capi, crea la rete percorsa da inconfondibili rigature Missoni.

Unique freestyle. Iconic and ironic, a hammock with an exotic soul and timeless identity, with double meaning, a unique decoration alongside total relaxation. The twisted three-strand threads have been hand-woven and create the artistic, polychrome interweave, in an unmistakably Missoni stripe.



Dettaglio *Detail*

LUNA

AMACA HAMMOCK

design by
MISSONI STUDIO
Made in Mexico

Materiali - Materials

Struttura: 100% filo di nylon ritorto a tre capi



OUTDOOR

Structure: 100% three strand nylon thread

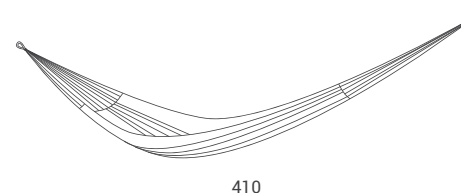

Peso netto	<i>Net weight</i>	2,2 kg
Peso con imballo	<i>Packed weight</i>	2,5 kg
Volume imballo	<i>Packed volume</i>	0,1 m³
Portata massima	<i>Maximum load</i>	200 kg

LIGHTING



BUBBLE KNIT

LAMPADA DA SOSPENSIONE PENDANT LAMP

Altri prodotti della collezione Knit:
pag. 126 - Drum Knit
Combinabile con lampade Bubble Nude:
pag. 118 - 120

Other products from Knit collection:
pag. 126 - Drum Knit
Combinable with Bubble Nude lamp:
pag. 118 - 120

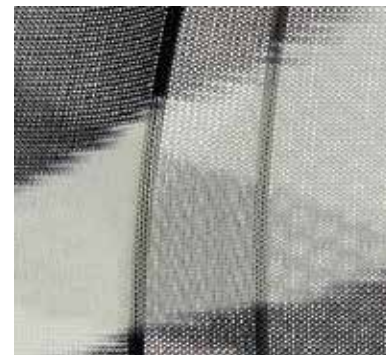

Dettaglio Detail



BEIGE 148

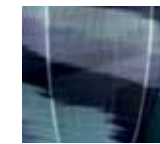

BLU 150



ARANCIO 159



BIANCO & NERO
601

LAMPADA DA SOSPENSIONE
PENDANT LAMP

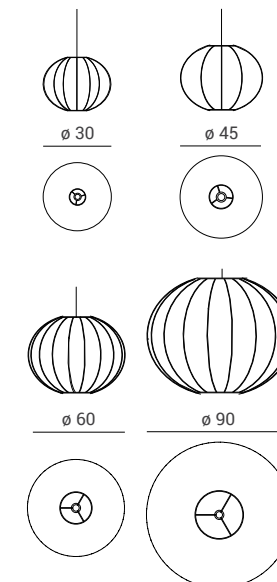

La luce e la fiamma. L'inconfondibile pattern Missoni avvolge la struttura sferica in acciaio curvato a mano. La cover di rivestimento in maglia calata è a scelta tra 4 diverse varianti di colorazione. Disponibile in 4 dimensioni.

Light and flame. Each spherical structure of hand-curved steel is wrapped in the unmistakable Missoni flame pattern mesh fabric, with 4 different colour variants and 4 different sizes.

BUBBLE KNIT

LAMPADA DA SOSPENSIONE PENDANT LAMP

design by
MISSONI STUDIO
Made in Italy

Materiali - Materials

Struttura: tondino di acciaio curvato a mano, verniciato a polvere d'alluminio

Rivestimento: tessuto di maglia di rayon (viscosa) sfoderabile, lavabile secondo le indicazioni riportate sull'etichetta. Il disegno a fiamma del rivestimento può variare a causa del processo di produzione artigianale della maglia

Lunghezza cavo: 300 cm

Colore cavo: nero

Kit elettrico venduto separatamente, in base alla tipologia di certificazione (UE o USA)

Alimentazione UE - Power supply UE

220 -240V - Eurospina CEE 7/16 (su richiesta adattatore UK BS 1363) - Sorgente luminosa: non inclusa. Attacco E27 (Ø 90, 60 e 45) / E14 (Ø 30) - Certificazione CE/IP20

Alimentazione USA - Power supply USA

110V - Spina A (NEMA 1-15) - Sorgente luminosa: non inclusa. E26 (Ø 90, 60 e 45) / E12 (Ø 30) - Certificazione IP20. Certificati UL



INDOOR



RIVESTIMENTO SFODERABILE
REMOVABLE COVER

Structure: hand-curved steel rod, powder coated aluminium
Upholstery: removable, rayon mesh fabric (viscose). Washable according to the instructions on the label. The flamed pattern of the coating may vary due to the artisan knitting production process

Cable length: 300 cm

Cable colour: black

Electric kit sold separately, depending on the type of certification required (UE or USA)

220-240V - Eurospina CEE 7/16 (UK BS 1363 adapter on request) - Lamp fitting: not included. E27 (Ø 90, 60 and 45) / E14 (Ø 30) - Certification CE / IP20

110V - Plug A (NEMA 1-15) - Lamp fitting: not included. E26 (Ø 90, 60 and 45) / E12 (Ø 30) - Certification IP20. UL Certified



Lampada Lamp	Peso netto Net weight	Peso con imballo Packed weight	Volume imballo Packed volume
Ø 30	1 kg	2,5kg	0,07 m ³
Ø 45	1,3 kg	3 kg	0,1 m ³
Ø 60	2 kg	5,5kg	0,25 m ³
Ø 90	3 kg	10 kg	0,75 m ³

BUBBLE KNIT

LAMPADA DA TERRA FLOOR LAMP

Altri prodotti della collezione Knit:
pag. 126 - Drum Knit
Combinabile con lampade Bubble Nude:
pag. 118 - 120

Other products from Knit collection:
pag. 126 - Drum Knit
Combinable with Bubble Nude lamp:
pag. 118 - 120

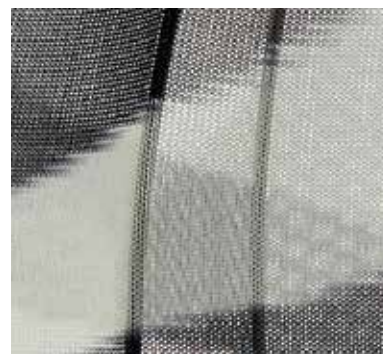

Dettaglio Detail



BEIGE 148

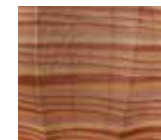

ARANCIO 159



BLU 150



BIANCO & NERO
601

BUBBLE KNIT

LAMPADA DA TERRA FLOOR LAMP

design by
MISSONI STUDIO
Made in Italy

Materiali - Materials

Struttura: tondino di acciaio curvato a mano, verniciato a polvere d'alluminio

Rivestimento: tessuto di maglia di rayon (viscosa) sfoderabile, lavabile secondo le indicazioni riportate sull'etichetta. Il disegno a fiamma del rivestimento può variare a causa del processo di produzione artigianale della maglia

Lunghezza cavo: 200 cm

Colore cavo: nero con dimmer

Kit elettrico venduto separatamente, in base alla tipologia di certificazione (UE o USA)

Alimentazione UE - Power supply UE

220 -240V - Eurospina CEE 7/16 (su richiesta adattatore UK BS 1363) - Sorgente luminosa: non inclusa. Attacco E27 (Ø 90, 60 e 45) / E14 (Ø 30) - Certificazione CE/IP20

Alimentazione USA - Power supply USA

110V - Spina A (NEMA 1-15) - Sorgente luminosa: non inclusa. E26 (Ø 90, 60 e 45) / E12 (Ø 30) - Certificazione IP20. Certificati UL



INDOOR



RIVESTIMENTO SFODERABILE
REMOVABLE COVER

Structure: hand-curved steel rod, powder coated aluminium
Upholstery: removable, rayon mesh fabric (viscose). Washable according to the instructions on the label. The flamed pattern of the coating may vary due to the artisan knitting production process

Cable length: 200 cm

Cable colour: black with switch

Electric kit sold separately, depending on the type of certification required (UE or USA)

220 -240V - Eurospina CEE 7/16 (UK BS 1363 adapter on request) - Lamp fitting: not included. E27 (Ø 90, 60 and 45) / E14 (Ø 30) - Certification CE / IP20

110V - Plug A (NEMA 1-15) - Lamp fitting: not included. E26 (Ø 90, 60 and 45) / E12 (Ø 30) - Certification IP20. UL Certified



La luce e la fiamma. L'inconfondibile pattern Missoni avvolge la struttura sferica in acciaio curvato a mano. La cover di rivestimento in maglia calata è a scelta tra 4 diverse varianti di colorazione. Disponibile in 4 dimensioni.

Light and flame. Each spherical structure of hand-curved steel is wrapped in the unmistakable Missoni flame pattern mesh fabric, with 4 different colour variants and 4 different sizes.

LAMPADA DA TERRA
FLOOR LAMP

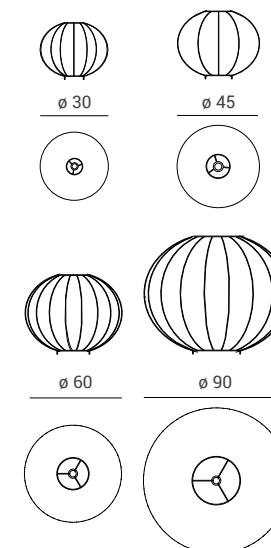

Lampada Lamp	Peso netto Net weight	Peso con imballo Packed weight	Volume imballo Packed volume
Ø 30	1 kg	2,5kg	0,07 m ³
Ø 45	1,3 kg	3 kg	0,1 m ³
Ø 60	2 kg	5,5kg	0,25 m ³
Ø 90	3 kg	10 kg	0,75 m ³

BUBBLE NUDE

LAMPADA DA SOSPENSIONE PENDANT LAMP

Combinabile con lampade rotonde:
Bubble Knit pag. 114 - 116 - Thea Kuta pag. 128

Combinable with round lamps:
Bubble Knit pag. 114 - 116 - Thea Kuta pag. 128

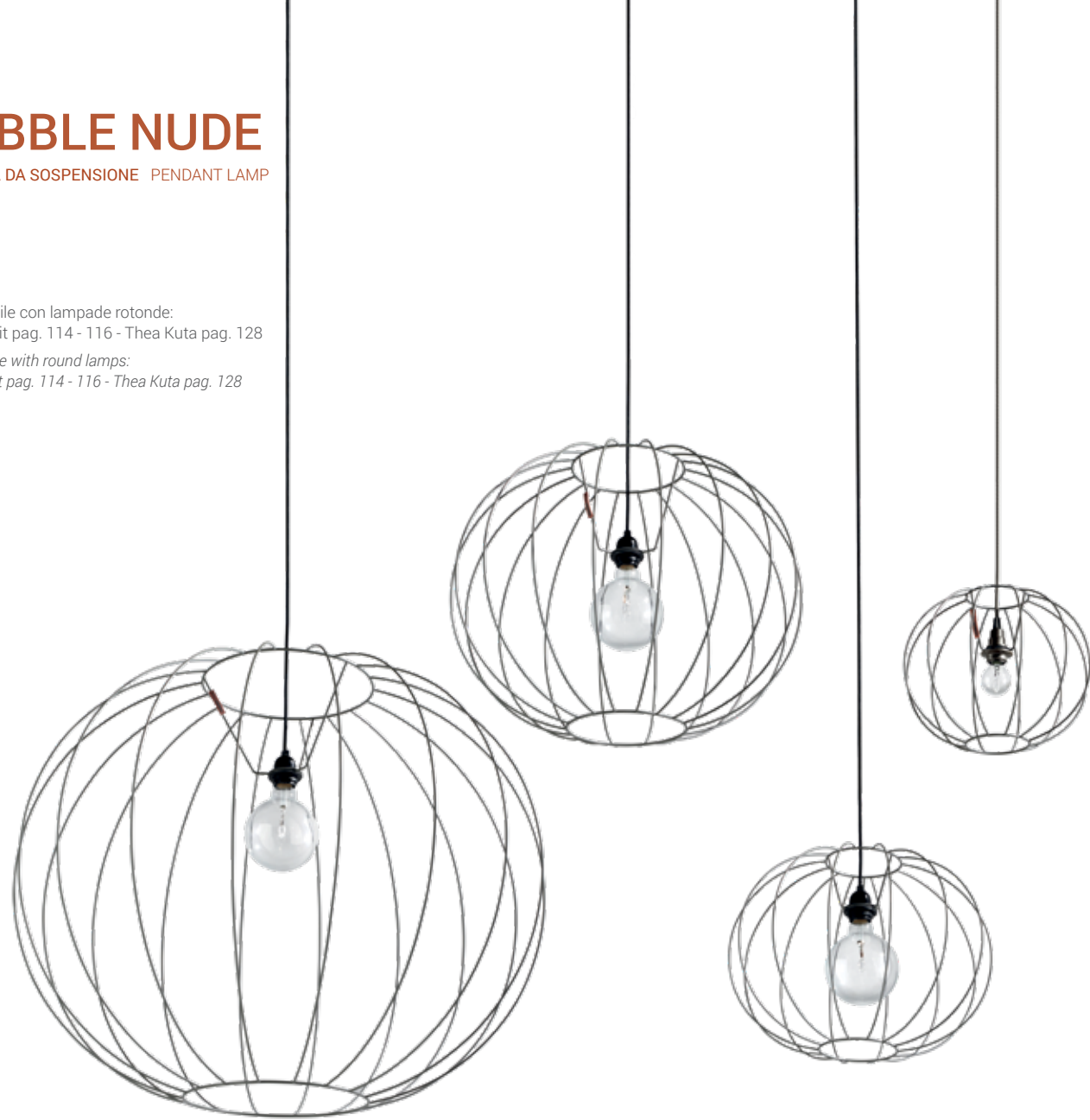

Luce essenziale. La struttura design del globo racchiude la luce diretta.
La gabbia metallica è piegata a mano e verniciata a polvere d'alluminio in due toni diversi, antracite oppure oro. Disponibile in 4 diverse dimensioni.

Essential light. Enclosing direct light, the design structure is like a globe.
Hand-curved metal, painted in either anthracite or gold aluminium powder, and available in 4 sizes.



ORO 40



ANTRACITE 86

LAMPADA DA SOSPENSIONE
PENDANT LAMP

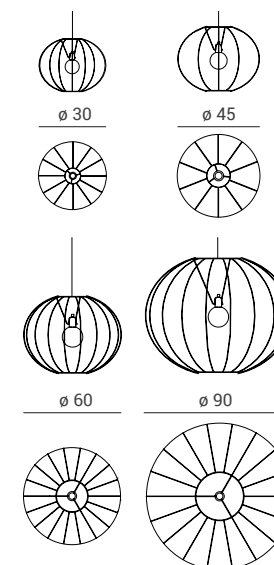

BUBBLE NUDE

LAMPADA DA SOSPENSIONE PENDANT LAMP

design by
MISSONI STUDIO
Made in Italy



INDOOR

Materiali - Materials

Struttura: tondino di acciaio curvato a mano, verniciato a polvere d'alluminio
Lunghezza cavo: 300 cm
Colore cavo: nero o oro
Kit elettrico venduto separatamente: in base alla tipologia di certificazione (UE o USA)

Structure: hand-curved steel rod, powder coated aluminium
Cable length suspension version: 300 cm
Cable colour: black or gold
Electric kit sold separately: depending on the type of certification required (UE or USA)

Alimentazione UE - Power supply UE

220 -240V - Eurospina CEE 7/16 (su richiesta adattatore UK BS 1363) - Sorgente luminosa: non inclusa. Attacco E27 (Ø 90, 60 e 45) / E14 (Ø 30) - Certificazione CE/IP20

220-240V - Eurospine CEE 7/16 (UK BS 1363 adapter on request) - Lamp fitting: not included. E27 (Ø 90, 60 and 45) / E14 (Ø 30) - Certification CE / IP20

Alimentazione USA - Power supply USA

110V - Spina A (NEMA 1-15) - Sorgente luminosa: non inclusa. E26 (Ø 90, 60 e 45) / E12 (Ø 30) - Certificazione IP20. Certificati UL

110V - Plug A (NEMA 1-15) - Lamp fitting: not included. E26 (Ø 90, 60 and 45) / E12 (Ø 30) - Certification IP20. UL Certified



Lampada Lamp	Peso netto Net weight	Peso con imballo Packed weight	Volume imballo Packed volume
Ø 30	0,9 kg	2,4 kg	0,07 m ³
Ø 45	1,2 kg	2,9 kg	0,1 m ³
Ø 60	1,8 kg	5,2 kg	0,25 m ³
Ø 90	2,7 kg	9,7 kg	0,75 m ³

BUBBLE NUDE

LAMPADA DA TERRA FLOOR LAMP

Combinabile con lampade rotonde:
Bubble Knit pag. 114 - 116 - Thea Kuta pag. 128

Combinable with round lamps:
Bubble Knit pag. 114 - 116 - Thea Kuta pag. 128



Luce essenziale. La struttura design del globo racchiude la luce diretta.
La gabbia metallica è piegata a mano e verniciata a polvere d'alluminio in due toni diversi, antracite oppure oro. Disponibile in 4 diverse dimensioni.

Essential light. Enclosing direct light, the design structure is like a globe.
Hand-curved metal, painted in either anthracite or gold aluminium powder, and available in 4 sizes.

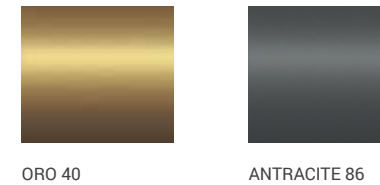

ORO 40

ANTRACITE 86

LAMPADA DA TERRA
FLOOR LAMP

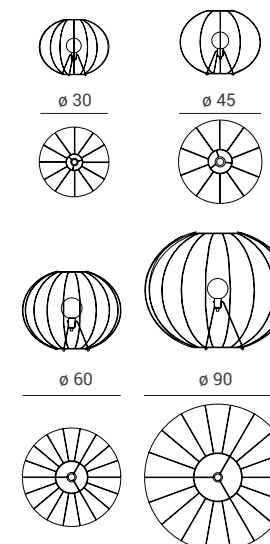

BUBBLE NUDE

LAMPADA DA TERRA FLOOR LAMP

design by
MISSONI STUDIO
Made in Italy



Materiali - Materials

Struttura: tondino di acciaio curvato a mano, verniciato a polvere d'alluminio
Lunghezza cavo: 200 cm
Colore cavo: nero o oro con dimmer
Kit elettrico venduto separatamente, in base alla tipologia di certificazione (UE o USA)

Structure: hand-curved steel rod, powder coated aluminium
Cable length floor version: 200 cm
Cable colour: black or gold with switch
Electric kit sold separately, depending on the type of certification required (UE or USA)

Alimentazione UE - Power supply UE

220 -240V - Eurospina CEE 7/16 (su richiesta adattatore UK BS 1363) - Sorgente luminosa: non inclusa. Attacco E27 (Ø 90, 60 e 45) / E14 (Ø 30) - Certificazione CE/IP20

220-240V - Eurospine CEE 7/16 (UK BS 1363 adapter on request) - Lamp fitting: not included. E27 (Ø 90, 60 and 45) / E14 (Ø 30) - Certification CE / IP20

Alimentazione USA - Power supply USA

110V - Spina A (NEMA 1-15) - Sorgente luminosa: non inclusa. E26 (Ø 90, 60 e 45) / E12 (Ø 30) - Certificazione IP20. Certificati UL

110V - Plug A (NEMA 1-15) - Lamp fitting: not included. E26 (Ø 90, 60 and 45) / E12 (Ø 30) - Certification IP20. UL Certified



Lampada Lamp	Peso netto Net weight	Peso con imballo Packed weight	Volume imballo Packed volume
Ø 30	0,9 kg	2,4 kg	0,07 m ³
Ø 45	1,2 kg	2,9 kg	0,1 m ³
Ø 60	1,8 kg	5,2 kg	0,25 m ³
Ø 90	2,7 kg	9,7 kg	0,75 m ³

CORDULA

LAMPADA PENDANT LAMP

Altri prodotti della collezione Cordula:
pag. 30 - 32 - 104 - 106

Other products from Cordula collection:
pag. 30 - 32 - 104 - 106



Luce e intreccio. Bulbo opalino luminoso ingabbiato da calotta a intreccio crochet. La corda annodata a mano con micro-zigzag multicolor crea una copertura impermeabile che consente l'uso delle lampade sia all'interno che all'esterno. Disponibili in 3 dimensioni.

Light and weave. A bright opal bulb is encased in a crocheted interlaced cover. The hand-knotted rope, with a multicolour micro-zigzag, creates a waterproof cover: for a lamp that can be used inside and outside. Available in 3 sizes.

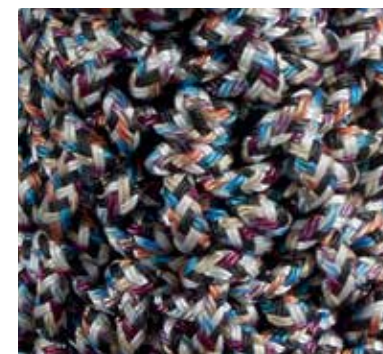

Dettaglio Detail

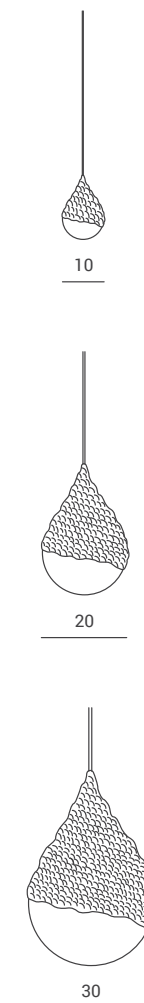

CORDULA

LAMPADA PENDANT LAMP

design by
OUCH! STUDIO
Made in Italy



Materiali - Materials

Bulbo versione Ø 10 cm: lampadina
Bulbo versioni Ø 20 e Ø 30 cm: calotta in PMMA, lampadina
Rivestimento: corda in PET HT a motivo chevron multicolor
Lunghezza cavo: 300 cm
Disegno cavo a motivo chevron multicolor

Alimentazione - Power supply

Presca elettrica CEE 7/16 compatibile con corrente elettrica 220-240V
Certificazione CE/IP20 per territori UE
Lampadina inclusa solo nel modello Ø 10
Alimentazioni USA non disponibile

Lampadina inclusa - Bulb included

Tecnologia CFL - attacco E27 - watt 23W (=95W)
temperatura colore 2700 K - lumen 1320 -
classe energetica A - IRC 81

*Bulb version Ø 10 cm: light bulb
Bulb versions Ø 20 and Ø 30 cm: shell in PMMA, light bulb
Covering: multicolour chevron motif PET HT rope
Cable length: 300 cm
Multicolour chevron motif cable*

*Electric socket CEE 7/16 compatible with 220-240V electric current
Certification CE / IP20 for EU territories
Bulb included only in Ø 10 model
Power supply USA not available*

*CFL technology - E27 connection - watt 23W (= 95W)
colour temperature 2700 K - 1320 lumens -
energy class A - IRC 81*



Lampada Lamp	Peso netto Net weight	Peso con imballo Packed weight	Volume imballo Packed volume
Ø 10	1,2 kg	1,5 kg	0,01 m ³
Ø 20	2 kg	3 kg	0,015 m ³
Ø 30	3,3 kg	5 kg	0,05 m ³

DRUM

LAMPADA PENDANT LAMP

Altri prodotti della collezione
Drum: pag. 126 - Drum Knit

Other products from
Drum collection: pag. 126 - Drum Knit



Luce e colore. Di forma cilindrica e in materiale opalino semitrasparente stampato a zigzag, il paralume a sospensione diffonde la luce in modo omogeneo. A scelta, da rivestire con cover in tessuto Missoni Home Collection. Disponibile in 2 diverse misure.

Light and colour. Cylindrical in shape and produced in a semi-transparent, zigzag printed, opaline material, the suspension lamp diffuses the light homogeneously. There is also the option to cover the lampshade with fabrics from the Missoni Home Collection. Available in 2 sizes.

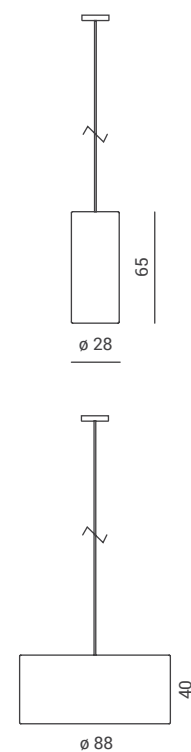

Dettaglio senza rivestimento
Detail without upholstery

DRUM

LAMPADA PENDANT LAMP

design by
MISSONI STUDIO
Made in Italy

Materiali - Materials

Struttura: tondino di acciaio, verniciato a polvere d'alluminio

Paralume: pannello in policarbonato o pvc stampato a motivo chevron tono-su-tono

Rivestimento: tessuto sfoderabile, lavabile secondo le indicazioni riportate sull'etichetta

È possibile utilizzare la lampada anche senza il rivestimento in tessuto

Lunghezza cavo: 300 cm - Colore cavo: nero

Kit elettrico venduto separatamente, in base alla tipologia di certificazione (UE o USA)

Alimentazione UE - Power supply UE

Alimentazione: 220-240V

Sorgente luminosa: non inclusa. E27

Certificazione CE / IP20

Alimentazione USA - Power supply USA

Alimentazione: 110V

Sorgente luminosa: non inclusa. E26

Certificazione IP20. Certificato UL



INDOOR



RIVESTIMENTO SFODERABILE
REMOVABLE COVER

Structure: steel rod, powder coated aluminium

Lampshade: polycarbonate or pvc panel printed in tonal chevron motif

Upholstery: removable fabric, washable according to the instructions on the label

It is possible to use the lamp without the fabric covering

Cable length: 300 cm - Cable colour: black

Electric kit sold separately, depending on the type of certification required (UE or USA)

Power supply: 220-240V

Lamp fitting: not included. E27

Certificazione CE / IP20

Power supply: 110V

Lamp fitting: not included. E26

Certification IP20. UL certified



Lampada Lamp	Peso netto Net weight	Peso con imballo Packed weight	Volume imballo Packed volume
Ø 28	1,3 kg	2,5 kg	0,01 m³
Ø 88	3,1 kg	9,1 kg	0,46 m³

DRUM KNIT

LAMPADA PENDANT LAMP

Altri prodotti della collezione
Drum: pag. 124 - Drum

Other products from
Drum collection: pag. 124 - Drum



Luce e materia. Di forma cilindrica variabile e in materiale opalino semi-trasparente a motivo zigzag, il paralume a sospensione diffonde la luce in modo omogeneo. Da rivestire con un cover di maglia calata nell'iconico motivo fiammato Missoni. Disponibile in 2 diverse misure.

Light and matter. Cylindrical in shape and produced in a semi-transparent, zigzag printed, opaline material, the suspension lamp diffuses the light homogeneously. Covered with an iconic Missoni flamed motif mesh fabric. Available in 2 sizes.

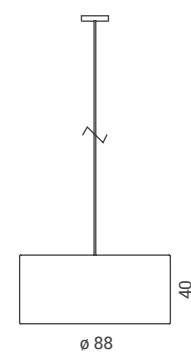
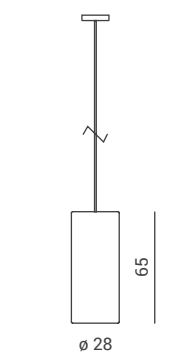

Dettaglio senza rivestimento
Detail without upholstery



BEIGE 148

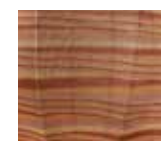

ARANCIO 159



BLU 150

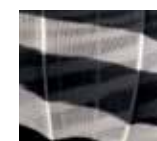

BIANCO & NERO
601

DRUM KNIT

LAMPADA PENDANT LAMP

design by
MISSONI STUDIO
Made in Italy

Materiali - Materials

Struttura: tondino di acciaio, verniciato a polvere d'alluminio

Paralume: pannello in policarbonato stampato a motivo chevron tono-su-tono

Rivestimento: tessuto di maglia di rayon (viscosa) sfoderabile, lavabile secondo le indicazioni riportate sull'etichetta. Il disegno a fiamma del rivestimento può variare a causa del processo di produzione artigianale della maglia

È possibile utilizzare la lampada anche senza il rivestimento in tessuto

Lunghezza cavo: 300 cm - Colore cavo: nero

Kit elettrico venduto separatamente, in base alla tipologia di certificazione (UE o USA)

Alimentazione UE - Power supply UE

Alimentazione: 220-240V

Sorgente luminosa: non inclusa. E27

Certificazione CE / IP20

Alimentazione USA - Power supply USA

Alimentazione: 110V

Sorgente luminosa: non inclusa. E26

Certificazione IP20. Certificato UL



INDOOR



RIVESTIMENTO SFODERABILE
REMOVABLE COVER

Structure: steel rod, painted with aluminum powder

Lampshade: polycarbonate panel printed in tonal chevron motif

Upholstery: removable, rayon mesh fabric (viscose). Washable according to the instructions on the label. The flamed pattern of the coating may vary due to the artisan knitting production process

It is possible to use the lamp without the fabric covering

Cable length: 300 cm - Cable colour: black

Electric kit sold separately, depending on the type of certification required (UE or USA)

Power supply: 220-240V

Lamp fitting: not included. E27

Certification CE / IP20

Power supply: 110V

Lamp fitting: not included. E26

Certification IP20. UL certified



Lampada Lamp	Peso netto Net weight	Peso con imballo Packed weight	Volume imballo Packed volume
Ø 28	1,3 kg	2,5 kg	0,01 m³
Ø 88	3,1 kg	9,1 kg	0,46 m³

THEA KUTA

LAMPADA PENDANT LAMP

Combinabile con lampade
Bubble Nude: pag. 118 - 120

Combinable with
Bubble Nude lamps: pag. 118 - 120



Dettaglio Detail



BIANCO &
NERO 601



MULTICOLOR
100



NERO
MULTICOLOR 160

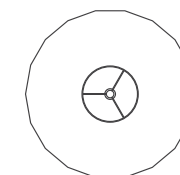
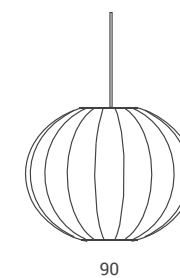

Luce e intrecci. La struttura sferica in metallo a sospensione è vestita con l'artistico intreccio a mano di fili policromi in lana che crea una ragnatela di colori nell'inconfondibile spirito Missoni. La luce che filtra dalla giocosa gabbia proietta ombre geometriche. Il globo multicolore della lampada spenta è elemento decorativo.

Light and weave. The spherical metal structure of this suspension lamp is covered with hand-woven multi-coloured wool threads, in the artistic and unmistakable Missoni spirit. The light that filters through the playful weaves casts geometric shadows. When unlit the globe of the lamp is a beautiful decorative element.

THEA KUTA

LAMPADA PENDANT LAMP

design by
ELISA BERTOLUSSI
Made in Italy

Materiali - Materials

Struttura: tondino di acciaio curvato a mano, verniciato a polvere d'alluminio
Rivestimento: 100% lana merinos extra fine
Lunghezza cavo: 300 cm
Colore cavo: nero
Kit elettrico venduto separatamente, in base alla tipologia di certificazione (UE o USA)

Alimentazione UE - Power supply UE

Alimentazione: 220-240V
Sorgente luminosa, Non inclusa.
Certificazione CE/IP20

Alimentazione USA - Power supply USA

Alimentazione: 110V
Sorgente luminosa: non inclusa. E26
Certificazione IP20. Certificati UL



INDOOR

Structure: hand-curved steel rod, powder coated aluminium
Covering: 100% extra fine merino wool
Cable length: 300 cm
Cable colour: black
Electric kit sold separately, depending on the type of certification required (UE or USA)

Power supply: 220-240V
Lamp fitting: not included.
Certification CE / IP20

Power supply: 110V
Lamp fitting: not included. E26
Certification IP20. UL Certified.



Peso netto	Net weight	2,9 kg
Peso con imballo	Packed weight	6,5 kg
Volume imballo	Packed volume	0,75 m³

SOPHIE

LAMPADA LAMP



Luce da vestire. La lampada da terra è sorretta da una snella struttura metallica e composta da un paralume cilindrico in policarbonato opalino stampato a zigzag che diffonde la luce in modo omogeneo. L'elemento può essere facilmente rivestito/svestito. Cover in tessuto a scelta Missoni Home Collection.

Dress the light. This floor lamp is supported by a slender metal structure and composed of a cylindrical lampshade in zigzag printed opal polycarbonate that diffuses light homogeneously. The lampshade can be used with or without a fabric Cover: to be chosen from the fabrics of the Missoni Home Collection.



Dettaglio senza rivestimento
Detail without upholstery

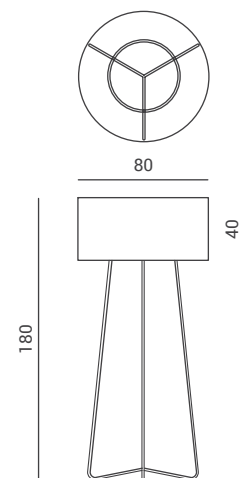

SOPHIE

LAMPADA LAMP

design by
MISSONI STUDIO
Made in Italy

Materiali - Materials

Struttura: tondino di acciaio, verniciato a polvere
Paralume: pannello in policarbonato stampato a motivo chevron tono-su-tono
Rivestimento: tessuto sfoderabile, lavabile secondo le indicazioni riportate sull'etichetta
Lunghezza cavo: 300 cm, con interruttore
Colore cavo: nero

Alimentazione UE - Power supply UE

Alimentazione: 220-240V - Eurospina CEE 7/16 (su richiesta adattatore UK BS 1363)
Sorgente luminosa: non inclusa. E27
Certificazione CE / IP20

Alimentazione USA non disponibile

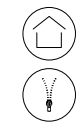

INDOOR



RIVESTIMENTO SFODERABILE
REMOVABLE COVER

Structure: powder coated steel rod
Lampshade: panel in polycarbonate printed with tonal chevron motif

Upholstery: removable fabric, washable according to the instructions on the label

Cable length: 300 cm, with switch

Cable colour: black

Power supply: 220-240V - Eurospine CEE7/16 (UK BS 1363 adapter on request)

Lamp fitting: not included. E27

Certification CE / IP20

Power supply USA not available



Peso netto
Peso con imballo
Volume imballo

Net weight
Packed weight
Packed volume

5,7 kg
10+5 kg
0,6+0,5 m³

SOPHIE KNIT

LAMPADA LAMP

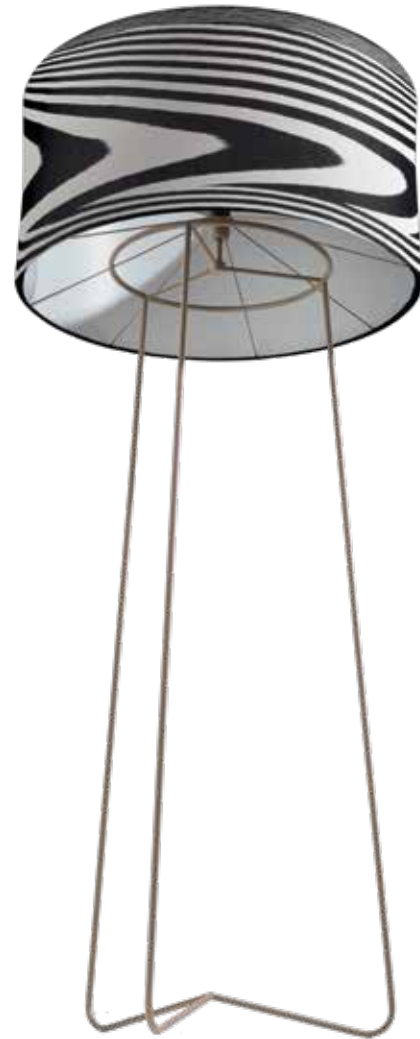

Luce soft. La lampada da terra è sorretta da una snella struttura metallica di tonalità beige e composta da un paralume cilindrico in policarbonato opalino stampato a chevron tono-su-tono e ricoperto in maglia fiammata. Il rivestimento, che favorisce la diffusione di una luce soffusa e omogenea, si rimuove facilmente. La scelta è tra quattro diverse varianti colore di tessuto in maglia della collezione Missoni Home Collection.

Soft light. The floor lamp is supported by a thin metallic structure in a beige tone and made up of a cylindrical lampshade in the same colour in chevron printed polycarbonate milk glass covered in shot fabric. The cover, which gives off a soft, even light, can be removed easily. The choice is among four different colour variations of knit fabric from the Missoni Home Collection.

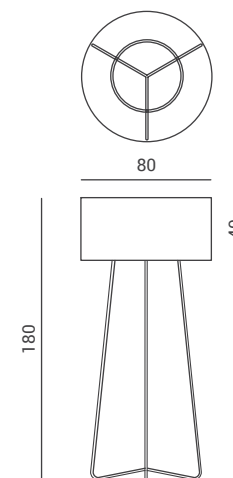

Dettaglio senza rivestimento
Detail without upholstery



BEIGE 148

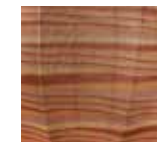

ARANCIO 159

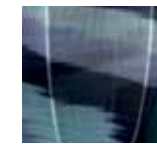

BLU 150



BIANCO & NERO
601

SOPHIE KNIT

LAMPADA LAMP

design by
MISSONI STUDIO
Made in Italy

Materiali - Materials

Struttura: tondino di acciaio, verniciato a polvere
Paralume: pannello in policarbonato stampato a motivo chevron tono-su-tono

Rivestimento: tessuto di maglia di rayon (viscosa) sfoderabile, lavabile secondo le indicazioni riportate sull'etichetta. Il disegno a fiamma del rivestimento può variare a causa del processo di produzione artigianale della maglia

È possibile utilizzare la lampada anche senza il rivestimento in tessuto

Lunghezza cavo: 300 cm, con interruttore

Colore cavo: nero

Alimentazione UE - Power supply UE

Alimentazione: 220-240V - Eurospina CEE 7/16 (su richiesta adattatore UK BS 1363)

Sorgente luminosa: non inclusa. E27

Certificazione CE/IP20

Alimentazione USA non disponibile



INDOOR



RIVESTIMENTO SFODERABILE
REMOVABLE COVER

Structure: powder coated steel rod

Lampshade: panel in polycarbonate printed with tonal chevron motif

Upholstery: removable, rayon mesh fabric (viscose). Washable according to the instructions on the label. The flamed pattern of the coating may vary due to the artisan knitting production process.

It is possible to use the lamp without the fabric covering

Cable length: 300 cm, with switch

Cable colour: black

Power supply: 220-240V - Eurospina CEE7/16 (UK BS 1363 adapter on request)

Lamp fitting: not included. E27

Certification CE / IP20

Power supply USA not available



Peso netto
Peso con imballo
Volume imballo

Net weight
Packed weight
Packed volume

5,7 kg
10+5 kg
0,6+0,5 m³

TESSUTI FABRICS



I	●	INDOOR	INDOOR
O	●	OUTDOOR	OUTDOOR
T.S	●	TENDE	SHEERS
A.F	●	ANTIFIAMMA	FLAME RET.

ROMA

ROMA

I O T.S A.F



BASEL

1B4P001 - Col. 22
140 CM - 55 IN
100% CO

Un vibrante effetto di contrapposizione fra riflessi lucidi e opachi contraddistingue l'iconico chevron di Basel, il tessuto decorativo in velluto di cotone tinto, dalla sorprendente mano tridimensionale.

A vibrant contrasting effect through shiny and opaque reflections distinguish the iconic chevron of Basel, the decorative fabric in dyed cotton velvet with the surprising three-dimensional touch.

I O T.S A.F



BASEL

1B4P001 - Col. 48
140 CM - 55 IN
100% CO

Un vibrante effetto di contrapposizione fra riflessi lucidi e opachi contraddistingue l'iconico chevron di Basel, il tessuto decorativo in velluto di cotone tinto, dalla sorprendente mano tridimensionale.

A vibrant contrasting effect through shiny and opaque reflections distinguish the iconic chevron of Basel, the decorative fabric in dyed cotton velvet with the surprising three-dimensional touch.

I O T.S A.F



BASEL

1B4P001 - Col. 62
140 CM - 55 IN
100% CO

Un vibrante effetto di contrapposizione fra riflessi lucidi e opachi contraddistingue l'iconico chevron di Basel, il tessuto decorativo in velluto di cotone tinto, dalla sorprendente mano tridimensionale.

A vibrant contrasting effect through shiny and opaque reflections distinguish the iconic chevron of Basel, the decorative fabric in dyed cotton velvet with the surprising three-dimensional touch.

I O T.S A.F



BASTIA

1B4Q004 - Col. 148
140 CM - 55 IN
100% PL

Calde sfumature dai toni naturali del legno e della sabbia si alternano a nuances declinate in una palette più fredda e polverosa nello zigzag ideato per Bastia, il tessuto decorativo jacquard flame retardant tinto in filo.

Warm shadings in natural tones of wood and sand alternate with nuances presented in a cooler, powdery palette in the zigzag created for Bastia, the flame-retardant dyed yarn jacquard fabric, with fading effect.

I O T.S A.F



BERGEN

1B4Q018 - Col. 481
140 CM - 55 IN
45% LI - 27% VI - 26% PL - 2% PA

Dà vita a un'inaspettata serie di giochi di scomposizione di chevron la texture dal riuscitissimo effetto mélange di Bergen, il tessuto decorativo jacquard tinto in filo, che incarna un irresistibile invito al tatto.

Giving life to an unexpected series of chevron breakdown games, the texture of the very successful mélange-effect Bergen, the jacquard decorative fabric in dyed yarn, embodying an irresistible invitation to the touch.

I O T.S A.F



BERGERAC

1B4Q003 - Col. 62
140 CM - 55 IN
66% VI - 34% PL

Ricorda le preziose lavorazioni a intarsio delle cattedrali romaniche la texture materica, dalle superbe sfumature avorio, che caratterizza Bergerac, il tessuto decorativo in velluto di viscosa effetto pizzo.

Calling to mind the precious inlay workmanship techniques of the Romanesque cathedrals, the material texture with superb ivory shadings, which characterises Bergerac, the decorative fabric in lace-effect viscose velvet.

ROMA

I O T.S A.F



BIARRITZ

1B4R002 - Col. 148
140 CM - 55 IN
100% PL

Tocchi di colore acquarellati e una festosa combinazione di pattern dal vago sapore liberty conferiscono dinamismo e fluidità a Biarritz, il tessuto decorativo in velluto flame retardant stampato a motivi floreali.

Touches of water-coloured colour and a festive pattern combination of a vague liberty flavour give dynamism and fluidity to Biarritz, the floral motif printed flame-retardant velvet decorative fabric.

I O T.S A.F



BIRMINGHAM

1B4Q021 - Col. 157
140 CM - 55 IN
100% PL

Tutto il dinamismo di accostamenti cromatici decisi, inseriti in una ritmata teoria di chevron, per la texture dai toni dégradé di Birmingham, il tessuto decorativo jacquard flame retardant tinto in filo.

All the vitality of clear chromatic pairings, inserted in a rhythmic chevron weave, for the texture with the fading tones of the Birmingham, the dyed yarn flame-retardant jacquard decorative fabric.

I O T.S A.F



BREST

1B4Q005 - Col. 481
140 CM - 55 IN
100% PL

Una tavolozza ridotta di colori e sfumature, che riesce ugualmente a stupire grazie a una lavorazione sofisticata, è la prerogativa principale di Brest, il tessuto decorativo jacquard flame retardant tinto in filo.

A reduced palette of colours and nuances, that is nonetheless able to amaze thanks to a sophisticated workmanship, this is the main prerogative of Brest, the flame-retardant dyed yarn jacquard decorative fabric.

I O T.S A.F

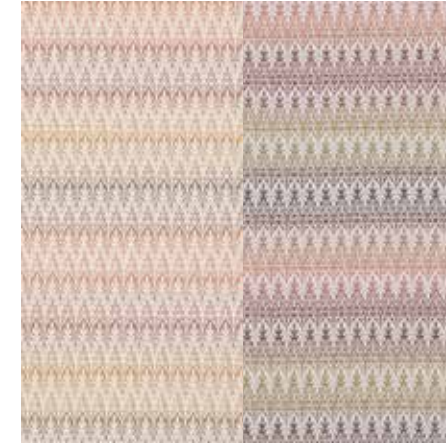

BRUGES

1B4Q011 - Col. 148 / 148R
130 CM - 51 IN
47% CO - 38% PL - 10% PC - 5% PM

I raggi del sole filtrati dai colori delle vetrate gotiche è la luce emanata dall'intrusione di filati metallici in lurex nella texture policroma di Bruges, il tessuto decorativo jacquard effetto Raschel.

The rays of the sun filtered by the colours of the Gothic glass windows is the light given off by the intrusion of the lurex metallic yarns in the polychrome texture of Bruges, the jacquard decorative fabric with Raschel effect.

I O T.S A.F



COOMBA

1H4PK03 - Col. 21
140 CM - 55 IN
62% VI - 38% CO

Si riveste di morbide scanalature che giocano con l'aspetto scultoreo dato dall'alternanza di pieni e di vuoti Coomba, il tessuto decorativo in velluto a coste tinto in pezza a effetto stropicciato.

Covered in soft grooves that play with the sculptural look given by the alternating of solids and hollows is the Coomba, in wrinkled effect dyed ribbed velvet decorative fabric.

I O T.S A.F



RABAT

1R4Q018 - Col. 62
135 CM - 53 IN
62% VI - 38% CO

Si riveste di morbide scanalature che giocano con l'aspetto scultoreo dato dall'alternanza di pieni e di vuoti Rabat, il tessuto decorativo in velluto a coste tinto in pezza a effetto stropicciato.

Covered in soft grooves that play with the sculptural look given by the alternating of solids and hollows is the Rabat, in wrinkled effect dyed ribbed velvet decorative fabric.

I O T.S A.F



BREST

1B4Q005 - Col. 861
140 CM - 55 IN
100% PL

Una tavolozza ridotta di colori e sfumature, che riesce ugualmente a stupire grazie a una lavorazione sofisticata, è la prerogativa principale di Brest, il tessuto decorativo jacquard flame retardant tinto in filo.

A reduced palette of colours and nuances, that is nonetheless able to amaze thanks to a sophisticated workmanship, this is the main prerogative of Brest, the flame-retardant dyed yarn jacquard decorative fabric.

I O T.S A.F



BRIDGETOWN

1B4Q008 - Col. 611
140 CM - 55 IN
70% WO - 20% PA - 10% PL

Multidimensionalità di linee e spiccata inclinazione al decorativissimo geometrico per il maxi-chevron bicolore di Bridgetown, il tessuto decorativo jacquard tinto in filo a effetto feltro.

Multidimensionality of lines and a strong inclination to geometric decorativism for the two-tone maxi-chevron of Bridgetown, the felt-effect dyed yarn jacquard decorative fabric.

I O T.S A.F



BRIGHTON

1B4Q020 - Col. 157
145 CM - 57 IN
100% PL

Nuances atmosferiche che disegnano mille orizzonti in grado di far viaggiare la mente in tutto il mondo per la coloratissima fantasia di Brighton, il tessuto decorativo jacquard flame retardant tinto in filo rigato.

Atmospheric nuances that design thousands of horizons able to make the mind travel throughout the world thanks to the very colourful Brighton print, the decorative, flame-retardant, jacquard fabric in striped dyed yarn.

I O T.S A.F

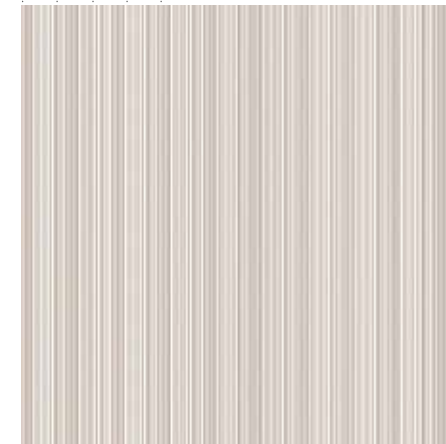

BOA VISTA

1B4TW01 - Col. 140
145x300 CM - 57x118 IN
100% VI

Mille frange multicolore, dalle nuances delicatissime che sembrano danzare al ritmo di un raffinato effetto vedo non vedo, animano di leggerezza la fantasia di Boa Vista, la tenda a pannello in pura viscosa.

Multicolour fringe, with delicate nuances that seem to dance to the rhythm of a refined see-through effect, enliven with lightness the print of the Boa Vista, the panel curtain in pure viscose.

I O T.S A.F



BOURGOGNE

1B4T001 - Col. 48
325 CM - 127 IN
100% LI

L'eleganza senza tempo del lino trova spazio nelle teorie di chevron che si alternano originando effetti di trasparenza unica sulla superficie di Bourgogne, la tenda in tessuto jacquard tinto in filo.

The timeless elegance of linen finds room in the chevron weaves that alternate giving rise to effects of unique transparency on the surface of Bourgogne, the curtain in dyed yarn jacquard fabric.

CALABASAS

CALABASAS

I O TS AF



BAKU

1B4Q010 - Col. 149 / 149R

135 CM - 53 IN
74% PL - 16% CO - 8% PC - 2% AC

Coniuga una preziosità di aspetto di sottile timbro artigianale all'energica combinazione di cromie e sfumature dal disegno vorticoso la texture di Baku, il tessuto decorativo jacquard tinto in filo effetto Raschel.

Combines a preciousity in appearance of a subtle craftsmanship-like stamp to the energetic combination of colour schemes and shadings with the swirling design of the texture of Baku, the jacquard decorative fabric in Raschel-effect dyed yarn.

I O TS AF



BANGALORE

1B4R004 - Col. 159

155 CM - 61 IN
100% PL

Una matericità soffice e avvolgente, in grado di irradiare il colore in morbide pennellate dall'aspetto acquarellato, contraddistingue l'originale texture di Bangalore, il tessuto decorativo in pelliccia stampata policroma.

A soft and enveloping material quality, able to radiate colour in soft strokes of a watercolour appearance, characterises the unique texture of Bangalore, the decorative fabric in polychrome printed fur.

I O TS AF



BEKASI

1B4Q016 - Col. 149

145 CM - 57 IN
78% PL - 22% CO

L'allure tra il fiabesco e il rinascimentale di un motivo disegnativo come la melograna assume un fascino vibrante e contemporaneo sulla texture di Bekasi, il tessuto decorativo jacquard tinto in filo a tema ramage.

The allure between the fairy tale and the Renaissance of a design motif like the pomegranate takes on a vibrant and contemporary charm on the texture of Bekasi, the foliage-themed dyed yarn jacquard decorative fabric.

I O TS AF



BERGEN

1B4Q018 - Col. 601

140 CM - 55 IN
45% LI - 27% VI - 26% PL - 2% PA

Dà vita a un'inaspettata serie di giochi di scomposizione di chevron la texture dal riuscitissimo effetto mélange di Bergen, il tessuto decorativo jacquard tinto in filo, che incarna un irresistibile invito al tatto.

Giving life to an unexpected series of chevron breakdown games, the texture of the very successful mélange-effect Bergen, the jacquard decorative fabric in dyed yarn, embodying an irresistible invitation to the touch.

I O TS AF



BHUTAN

1B4Q017 - Col. 149

145 CM - 57 IN
93% PL - 7% PA

Restituisce l'idea di un mondo fantastico, visto attraverso i colori di un vetro smerigliato, la texture policroma che dona ritmo e armonia a Bhutan, il tessuto decorativo jacquard tinto in filo a tema camouflage.

The polychrome texture that gives rhythm and harmony to Bhutan, the camouflage-themed dyed yarn jacquard decorative fabric, gives back the idea of a fantastic world seen through the colours of a frosted glass.

I O TS AF



BOUGAINVILLE

1B4Q006 - Col. 149 / 149R

140 CM - 55 IN
55% PL - 23% WO - 20% AR - 2% PA

Eclettismo e versatilità come nuove parole d'ordine del living contemporaneo sembra essere il mantra incarnato perfettamente da Bougainville, il tessuto decorativo jacquard tinto in filo stampato double.

Eclecticism and versatility used as new codewords for contemporary living seem to be the mantra personified perfectly by Bougainville, the double printed dyed yarn jacquard decorative fabric.

CALABASAS

I O T.S A.F



BRUNEI

1B4Q012 - Col. 149

140 CM - 55 IN
45% VI - 41% CO - 10% PC - 4% PL

Una classe che sceglie di non rinunciare al segno iconico dello chevron, è quella che caratterizza la texture multicolore di Brunei, il tessuto jacquard tinto in filo con motivo sfumato di zig-zag.

A style that chooses to not give up on the iconic symbol of the chevron, is that characterised by the multicoloured texture of Brunei, the dyed yarn jacquard fabric with shaded zigzag motif.

I O T.S A.F



BANGKOK

1B4K013 - Col. 149

150 CM - 59 IN
75% PP - 25% PL

Strizza l'occhio alle numerose sfumature atmosferiche dei paesaggi autunnali di montagna, la fantasia di onde policrome che si sovrappongono e si disallineano sulla superficie di Bangkok, il tessuto decorativo outdoor multicolore.

The polychrome waves print, overlapping and unaligned on the surface of the Bangkok, the multicolour outdoor decorative fabric, winks at the numerous atmospheric shadings of the autumn landscapes of the mountain.

I O T.S A.F

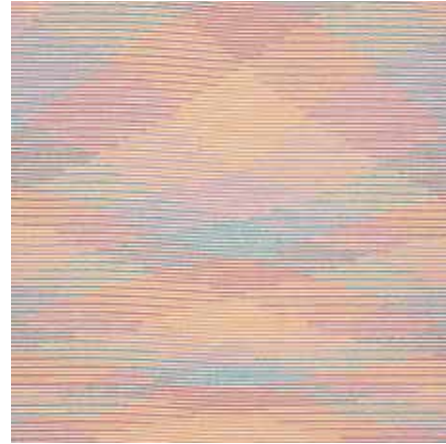

BELLEVILLE

1B4T002 - Col. 159

150 CM - 59 IN
43% WO - 16% CO - 15% AC - 15% PL - 11% SE

Una sinfonia multicolor di trasparenze e sfumature, che lascia intravedere teorie geometriche di motivi romboidali, è l'arma su cui sembra puntare la texture di Belleville, la tenda in tessuto jacquard tinto in filo effetto maglia.

A multicolour symphony of transparency and nuances, making it possible to distinguish geometric weaves of rhombus motifs, is the weapon on which the texture of Belleville seems to aim. Belleville is the curtain in knit-effect dyed yarn jacquard fabric.

I O T.S A.F



BOA VISTA

1B4TW01 - Col. 140

145x300 CM - 57x118 IN
100% VI

Mille frange multicolore, dalle nuances delicatissime che sembrano danzare al ritmo di un raffinato effetto vedo non vedo, animano di leggerezza la fantasia di Boa Vista, la tenda a pannello in pura viscosa.

Multicolour fringe, with delicate nuances that seem to dance to the rhythm of a refined see-through effect, enliven with lightness the print of the Boa Vista, the panel curtain in pure viscose.

BALI

BALI

I O TS AF



BARACOA

1B4P002 - Col. 21

135 CM - 53 IN
57% VI - 43% CO

Rievoca il fascino materico delle superfici di elementi naturali, declinate in una gamma di sfumature dai toni caldi e terrosi, la texture proposta per Baracoa, il tessuto decorativo in ciniglia tinta monocroma.

Revokes the material charm of the surfaces of natural elements, presented in a range of shades in warm and earthy tones, the texture presented for Baracoa, the decorative fabric in monochrome dyed chenille.

I O TS AF



BARACOA

1B4P002 - Col. 40

135 CM - 53 IN
57% VI - 43% CO

Rievoca il fascino materico delle superfici di elementi naturali, declinate in una gamma di sfumature dai toni caldi e terrosi, la texture proposta per Baracoa, il tessuto decorativo in ciniglia tinta monocroma.

Revokes the material charm of the surfaces of natural elements, presented in a range of shades in warm and earthy tones, the texture presented for Baracoa, the decorative fabric in monochrome dyed chenille.

I O TS AF



BARACOA

1B4P002 - Col. 59

135 CM - 53 IN
57% VI - 43% CO

Rievoca il fascino materico delle superfici di elementi naturali, declinate in una gamma di sfumature dai toni caldi e terrosi, la texture proposta per Baracoa, il tessuto decorativo in ciniglia tinta monocroma.

Revokes the material charm of the surfaces of natural elements, presented in a range of shades in warm and earthy tones, the texture presented for Baracoa, the decorative fabric in monochrome dyed chenille.

I O TS AF

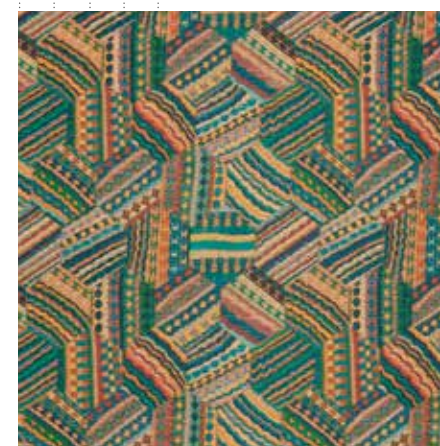

BARBUDA

1B4Q009 - Col. 100

140 CM - 55 IN
45% PL - 20% PC - 20% WO - 14% CO - 1% AF

Un'originale fantasia di maxi esagoni dalle mille sfumature, che riescono a catapultare l'occhio in un avvincente caleidoscopio di colori e geometrie, è quella che caratterizza la texture di Barbuda, il tessuto decorativo jacquard patchwork tinto in filo.

An original print of maxi-hexagons of a thousand shadings, able to send the eye to a captivating kaleidoscope of colours and geometries, that is what characterises the texture of Barbuda, the dyed yarn patchwork jacquard decorative fabric.

I O TS AF

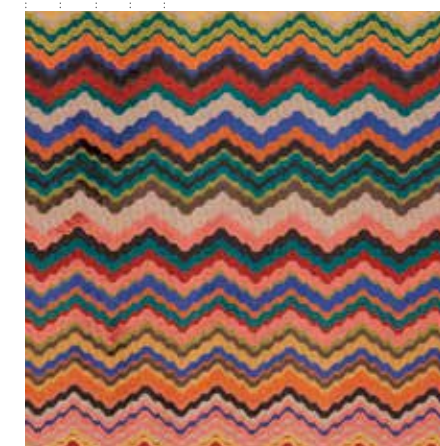

BAYAHIBE

1B4Q019 - Col. 100

135 CM - 53 IN
80% VI - 10% CO - 10% PL

Porge il benvenuto in ogni ambiente con la brillantezza di colori e sfumature rubate alle realtà urbane delle coste caraibiche Bayahibe, il tessuto in velluto di viscosa a maxi chevron.

The Bayahibe cylinder pouf offers a greeting in every home environment with the brilliance of colours and nuances stolen from the urban settings of the Caribbean coasts. Bayahibe is maxi-chevron viscose velvet fabric.

I O TS AF



BERGEN

1B4Q018 - Col. 481

140 CM - 55 IN
45% LI - 27% VI - 26% PL - 2% PA

Dà vita a un'inaspettata serie di giochi di scomposizione di chevron la texture dal riuscitissimo effetto mélange di Bergen, il tessuto decorativo jacquard tinto in filo, che incarna un irresistibile invito al tatto.

Giving life to an unexpected series of chevron breakdown games, the texture of the very successful mélange-effect Bergen, the jacquard decorative fabric in dyed yarn, embodying an irresistible invitation to the touch.

I O T.S A.F

**BELIZE****1B4K002 - Col. 59**140 CM - 55 IN
100% PL

Vibrazioni di creatività irrompono per animare con spirito contemporaneo le divertenti diagonali di chevron che movimentano la texture di Belize, il tessuto decorativo outdoor in tela stampata.

Vibrations of creativity burst through to liven up with a contemporary spirit the fun chevron diagonals that enliven the texture of Belize, the outdoor decorative fabric in printed canvas.

I O T.S A.F

**BELIZE****1B4K002 - Col. 70**140 CM - 55 IN
100% PL

Vibrazioni di creatività irrompono per animare con spirito contemporaneo le divertenti diagonali di chevron che movimentano la texture di Belize, il tessuto decorativo outdoor in tela stampata.

Vibrations of creativity burst through to liven up with a contemporary spirit the fun chevron diagonals that enliven the texture of Belize, the outdoor decorative fabric in printed canvas.

I O T.S A.F

**BELMOPAN****1B4K007 - Col. 100**145 CM - 57 IN
90% PP - 10% PC

Linee geometriche appositamente ideate per sottolineare la matericità della texture, danno vita a raffinati intrecci multicolori che definiscono il fascino sottilmente folk di Belmopan, il tessuto decorativo outdoor tinto in massa.

Geometric lines specifically created to underline the material quality of the textures give life to refined multicolour weaves that define the subtly folk charm of Belmopan, the solution dyed outdoor decorative fabric.

I O T.S A.F

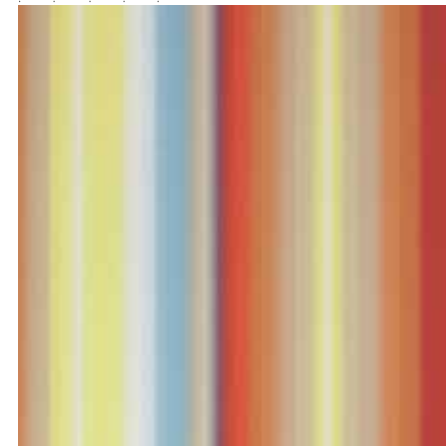
**TONGA OUTDOOR****1T4K003 - Col. 159**150 CM - 59 IN
100% PC

Atmosfera rarefatta e sofisticata, che sembra immortalare la delicatezza di nuances di un paesaggio immerso nella nebbia, per l'elegante fantasia scelta per Tonga, il tessuto outdoor tinto in massa rigato.

Rarefied and sophisticated atmosphere that seems to keep alive the delicacy of nuances of a landscape set in the fog, for the elegant print chosen for Tonga, the solution dyed striped outdoor fabric.

I O T.S A.F

**TONGA OUTDOOR****1T4K003 - Col. 170**150 CM - 59 IN
100% PC

Atmosfera rarefatta e sofisticata, che sembra immortalare la delicatezza di nuances di un paesaggio immerso nella nebbia, per l'elegante fantasia scelta per Tonga, il tessuto outdoor tinto in massa rigato.

Rarefied and sophisticated atmosphere that seems to keep alive the delicacy of nuances of a landscape set in the fog, for the elegant print chosen for Tonga, the solution dyed striped outdoor fabric.

I O T.S A.F

**BOGOTA****1B4K003 - Col. 100**140 CM - 55 IN
100% PL

Un coloratissimo tappeto di maxi-foglie, formatosi al passaggio di un vento della creatività, sembra adagiarsi a poco poco sulla superficie di Bogotà, il tessuto decorativo outdoor in tela stampata con motivo floreale.

A colourful rug with maxi-foilage, formed with the arrival of a gust of creativity, seems to ease down little by little on the surface of Bogotà, the floral print canvas outdoor decorative fabric.

I O T.S A.F

**BOLIVIA****1B4K009 - Col. 100**145 CM - 57 IN
90% PP - 10% PC

Mille righe arcobaleno in grado di esaltare la superficie materica, come se composta da diverse tessere di un mosaico policromo, scandiscono la texture di Bolivia, il tessuto decorativo outdoor tinto in massa.

Thousands of rainbow stripes able to exalt the surface of the material as if it were made up of various weaves of a polychrome mosaic, punctuate the texture of Bolivia, the solution dyed outdoor decorative fabric.

I O T.S A.F

**BONAMPAK****1B4K011 - Col. 100**140 CM - 55 IN
100% PL

La delicatezza delle sfumature scelte, declinate in morbide tonalità neutre, esalta in maniera perfetta la sofficità degli chevron che si muovono sul fondo dégradé di Bonampak, il tessuto decorativo outdoor jacquard tinto in filo bouclé.

The delicacy of the chosen nuances, presented in soft neutral tones, perfectly exalts the softness of the chevrons which move on the fading background of the Bonampak, the dyed bouclé yarn jacquard outdoor decorative fabric.

COURCHEVEL

COURCHEVEL

I O TS AF



BANFF

1B4Q014 - Col. 159

140 CM - 55 IN
46% PC - 15% PL - 15% WO - 14% VI - 10% AF

Delicate striature policrome, dal tratto quasi impercettibile come linee tracciate da gessetti, vivacizzano il fondo metallico dai bagliori di lurex color bronzo per Banff, il tessuto decorativo jacquard tinto in filo.

Delicate polychrome streaks, with a stroke that is almost undetectable like lines drawn by chalk, liven the metallic background with shimmers of bronze-coloured lurex for Banff, the dyed yarn jacquard decorative fabric.

I O TS AF



BILLINGS

1B4Q001 - Col. 159

140 CM - 55 IN
78% VI - 22% PL

Evoca sottilmente il coloratissimo senso estetico dei Seventies la fantasia di zigzag che scandisce come un serrato mosaico di geometrie policrome la texture di Billings, il tessuto decorativo jacquard tinto in filo.

The zigzag print of the Billings texture that punctuates like a dense mosaic of polychrome geometries subtly brings to mind the very colourful aesthetic sense of the Seventies. Billings is presented here in the dyed yarn jacquard decorative fabric.

I O TS AF



BANGOR

1B4Q022 - Col. 159

135 CM - 53 IN
92% VI - 8% PL

Una sinfonia di morbide stratificazioni policrome, come un soffice arcobaleno di sapore post-impressionista, è quella orchestrata dalla coloratissima texture di Bangor, il tessuto decorativo in velluto di viscosa tinto in filo rigato.

A symphony of soft polychrome layering, like a soft rainbow of post-impressionist flavour, it that which is orchestrated by the colourful texture of Bangor, the decorative fabric in dyed striped-yarn viscose velvet.

I O TS AF



BISCAYNE

1B4Q002 - Col. 159 / 159R

140 CM - 55 IN
70% VI - 30% PL

Una morbida fantasia di colori fluidi, che sembrano rincorrersi creando vibrazioni e disallineamenti dalle mille sfumature, caratterizza la texture di Biscayne, il tessuto decorativo jacquard tinto in filo.

A soft print of fluid colours, which seem to run after themselves creating vibrations and misalignments of a thousand shadings, characterises the texture of the Biscayne, the dyed yarn jacquard decorative fabric.

I O TS AF



BEAUMONT

1B4R003 - Col. 159

155 CM - 61 IN
100% PL

Un originale e immaginifico effetto di sfocatura multicolor a tinte abbaglianti si intrecciano sulla texture di Beaumont, il tessuto decorativo in pelliccia stampata con motivo macro fiammato policromo.

The superimposition of dazzling tones are woven together with an original and imaginative effect of multicolour blurring on the texture of Beaumont, the decorative fabric in printed fur with polychrome macro shot fabric motif.

I O TS AF



BOULDER

1B4Q013 - Col. 159

145 CM - 57 IN
35% CO - 32% WO - 31% PL - 2% PA

Pennellate di colore disegnano geometrie evocative della tradizione scozzese sulla texture di Boulder, il tessuto decorativo jacquard tinto in filo a effetto tartan.

Brush strokes of colour drawing evocative geometries of Scottish tradition on the texture of Boulder, the plaid-effect dyed yarn jacquard decorative fabric.

COURCHEVEL

I O T.S A.F



BRIDGETOWN

1B4Q008 - Col. 481

140 CM - 55 IN
70% WO - 20% PA - 10% PL

Multidimensionalità di linee e spiccata inclinazione al decorativissimo geometrico per il maxi-chevron bicolore di Bridgetown, il tessuto decorativo jacquard tinto in filo a effetto feltro.

Multidimensionality of lines and a strong inclination to geometric decorativism for the two-tone maxi-chevron of Bridgetown, the felt-effect dyed yarn jacquard decorative fabric.

I O T.S A.F



BROOKLYN

1B4Q007 - Col. 159

140 CM - 55 IN
38% PC - 38% WO - 14% PA - 10% PL

Anima pop che accende di colore metropolitano, il logo lettering dalle mille sfumature proposto per la texture di Brooklyn, il tessuto decorativo jacquard tinto in filo stampato.

Pop soul that lightens up with metropolitan colour, the logo lettering of a thousand shades presented in the texture of the Brooklyn, the jacquard decorative fabric in dyed yarn.

I O T.S A.F



MOOMBA

1H4QI87 - Col. T48

140 CM - 55 IN
71% VI - 25% CO - 4% PL

Dà vita a un'inaspettata serie di giochi di colore la texture dal riuscitissimo effetto mélange di Moomba, il tessuto decorativo jacquard tinto in filo, che incarna un irresistibile invito al tatto.

Giving life to an unexpected series of color games, the texture of the very successful mélange-effect Bergen, the jacquard decorative fabric in dyed yarn, embodying an irresistible invitation to the touch.

I O T.S A.F



RABAT

1R4Q018 - Col. 40

135 CM - 53 IN
62% VI - 38% CO

Si riveste di morbide scanalature che giocano con l'aspetto scultoreo dato dall'alternanza di pieni e di vuoti Rabat, il tessuto decorativo in velluto a coste tinto in pezza a effetto stropicciato.

Covered in soft grooves that play with the sculptural look given by the alternating of solids and hollows is the Rabat, in wrinkled effect dyed ribbed velvet decorative fabric.

I O T.S A.F



RABAT

1R4Q018 - Col. 62

135 CM - 53 IN
62% VI - 38% CO

Si riveste di morbide scanalature che giocano con l'aspetto scultoreo dato dall'alternanza di pieni e di vuoti Rabat, il tessuto decorativo in velluto a coste tinto in pezza a effetto stropicciato.

Covered in soft grooves that play with the sculptural look given by the alternating of solids and hollows is the Rabat, in wrinkled effect dyed ribbed velvet decorative fabric.

I O T.S A.F



BERKELEY

1B4K012 - Col. 159

145 CM - 57 IN
100% PL

Richiama alla mente certe illusioni ottiche tipiche delle visionarie opere di Escher la serie di macro motivi geometrici multicolor che animano la superficie di Berkeley, il tessuto decorativo outdoor a effetto maglia.

The series of macro-multicolour geometric motifs that liven up the surface of Berkeley, the knit-effect outdoor decorative fabric recalls to the mind certain typical optical illusions of the visionary works by Escher.

NEW YORK

NEW YORK

I O TS AF



BELEM

1B4R001 - Col. 160

145 CM - 57 IN
100% CO

Le più diverse sfumature della terra, del legno e del cuoio si affiancano nel poetico foliage stilizzato che regala carattere e unicità alla texture di Belem, il tessuto decorativo in raso stampato a tema floreale.

The most diverse nuances of the earth, wood and leather go hand in hand in the poetic, stylised foliage that gives character and uniqueness to the texture of Belem, the decorative fabric in printed satin in a floral theme.

I O TS AF

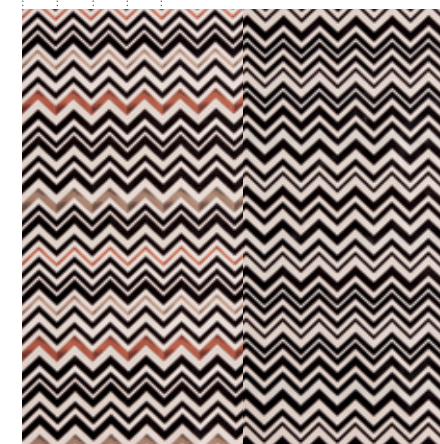

BELFAST

1B4Q023 - Col. 160 / 160R

140 CM - 55 IN
100% PL

Riattualizza l'elemento grafico più iconico, lo chevron, declinandolo in una variante di sorprendente modernità, la texture multicolore di Belfast, il tessuto decorativo jacquard tinto in filo flame retardant.

Updates the most iconic graphic element, the chevron, presenting it in a surprisingly modern variation, the multi-colour texture of Belfast, the jacquard decorative fabric in flame-retardant dyed yarn.

I O TS AF



BERGEN

1B4Q018 - Col. 481

140 CM - 55 IN
45% LI - 27% VI - 26% PL - 2% PA

Dà vita a un'inaspettata serie di giochi di scomposizione di chevron la texture dal riuscitissimo effetto mélange di Bergen, il tessuto decorativo jacquard tinto in filo, che incarna un irresistibile invito al tatto.

Giving life to an unexpected series of chevron breakdown games, the texture of the very successful mélange-effect Bergen, the jacquard decorative fabric in dyed yarn, embodying an irresistible invitation to the touch.

I O TS AF



BERN

1B4Q015 - Col. 21

135 CM - 53 IN
52% PC - 22% WO - 17% CO - 5% PL - 4% AF

Forma e colore sembrano fondersi perfettamente, dando vita a una coinvolgente morbidezza di sensazioni, grazie al macro tricot effetto maglia che caratterizza le texture di Bern, il tessuto decorativo in misto lana a spina di pesce.

Form and colour seem to blend perfectly, giving life to a captivating softness of sensations, thanks to the macro knit-effect tricot that characterises the textures of Bern, the herringbone wool blend decorative fabric.

I O TS AF



BIRMINGHAM

1B4Q021 - Col. 160

140 CM - 55 IN
100% PL

Tutto il dinamismo di accostamenti cromatici decisi, inseriti in una ritmata teoria di chevron, per la texture dai toni dégradé di Birmingham, il tessuto decorativo jacquard flame retardant tinto in filo.

All the vitality of clear chromatic pairings, inserted in a rhythmic chevron weave, for the texture with the fading tones of the Birmingham, the dyed yarn flame-retardant jacquard decorative fabric.

I O TS AF



BRIGHTON

1B4Q020 - Col. 160

145 CM - 57 IN
100% PL

Nuances atmosferiche che disegnano mille orizzonti in grado di far viaggiare la mente in tutto il mondo per la coloratissima fantasia di Brighton, il tessuto decorativo jacquard flame retardant tinto in filo rigato.

Atmospheric nuances that design thousands of horizons able to make the mind travel throughout the world thanks to the very colourful Brighton print, the decorative, flame-retardant, jacquard fabric in striped dyed yarn.

NEW YORK

I O T.S A.F



BALEARES

1B4K010 - Col. 160
140 CM - 55 IN
100% PL

Ecosostenibilità e naturalezza si incontrano per convivere fianco a fianco negli chevron dall'aspetto materico che caratterizzano la texture di Baleares, il tessuto decorativo outdoor in filati riciclati.

Eco-sustainability and naturalness meet to co-exist side by side in the chevron of a material aspect characterising the texture of Baleares, the outdoor decorative fabric in recycled yarns.

I O T.S A.F



BARCELONA

1B4K005 - Col. 160
140 CM - 55 IN
94% PP - 6% PC

Anima artigianale e texture materica, sottolineate da campiture di spessore variabile realizzate con lavorazioni diverse, sono le prerogative principali di Barcelona, il tessuto decorativo outdoor barré tinto in massa.

Artisan soul and material texture, underlined by backgrounds of variable thickness realised with different workmanship techniques, are the main prerogatives of Barcelona, the solution dyed barré outdoor decorative fabric.

I O T.S A.F



BATH

1B4K006 - Col. 48 / 48R
145 CM - 57 IN
66% PP - 34% PC

Punta su abbinamenti di colore più smorzati, che indagano le potenzialità espressive di toni vicini al bianco e nero, la texture materica e vibrante al tempo stesso di Bath, il tessuto outdoor double in viscosa.

Focussing on softer colour pairings, which examine the expressive potentials of tones close to black and white, the material and at the same time vibrant texture of Bath, the viscose double outdoor fabric.

I O T.S A.F

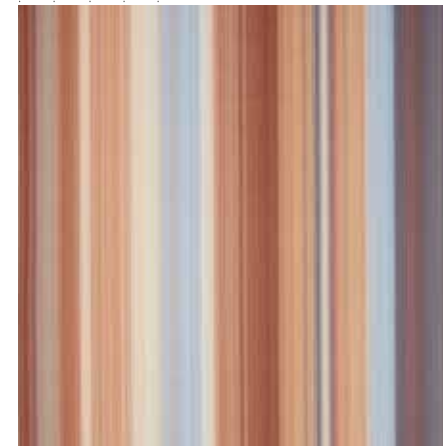

YUMBEL

1Y4K001 - Col. 160
145 CM - 57 IN
100% PC

Atmosfera rarefatta e sofisticata, che sembra immortalare la delicatezza di nuances di un paesaggio immerso nella nebbia, per l'elegante fantasia scelta per Yumbel, la tenda in tessuto outdoor tinto in massa rigato.

Rarefied and sophisticated atmosphere that seems to keep alive the delicacy of nuances of a landscape set in the fog, for the elegant print chosen for Yumbel, the curtain in solution dyed striped outdoor fabric.

I O T.S A.F

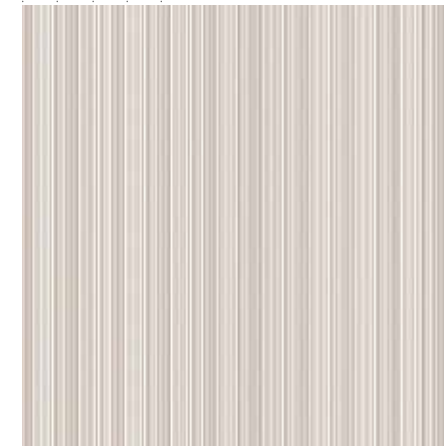

BOA VISTA

1B4TW01 - Col. 140
145x300 CM - 57x118 IN
100% VI

Mille frange multicolore, dalle nuances delicatissime che sembrano danzare al ritmo di un raffinato effetto vedo non vedo, animano di leggerezza la fantasia di Boa Vista, la tenda a pannello in pura viscosa.

Multicolour fringe, with delicate nuances that seem to dance to the rhythm of a refined see-through effect, enliven with lightness the print of the Boa Vista, the panel curtain in pure viscose.

I O T.S A.F



TAJMYR

1T4T001 - Col. 164
300 CM - 118 IN
95%LI - 5%PL

Nuances atmosferiche che disegnano mille orizzonti in grado di far viaggiare la mente in tutto il mondo per la coloratissima fantasia di Tajmyr, la tenda jacquard tinto in filo rigato.

Atmospheric nuances that design thousands of horizons able to make the mind travel throughout the world thanks to the very colourful Tajmyr sheer, the decorative jacquard fabric in striped dyed yarn.

I O T.S A.F



BILBAO

1B4K001 - Col. 160
145 CM - 57 IN
100% PC

Sembra riassumere ed accostare le più diverse sfumature della sabbia e del legno la fantasia millerighe che riscalda di naturalezza la texture di Bilbao, il tessuto decorativo outdoor tinto in massa.

The thousand-striped print that naturally warms the texture of Bilbao, the solution dyed outdoor decorative fabric, seems to take on once again and match the most varied nuances of sand and wood.

I O T.S A.F



BODRUM

1B4K008 - Col. 160
145 CM - 57 IN
62% PP - 38% PC

Gradazioni di colore simili ai toni della sabbia e della terracotta scandiscono con ritmo serrato la fantasia ricercatissima proposta per Bodrum, il tessuto decorativo outdoor barré tinto in massa.

Shades of colour similar to the tones of sand and terracotta punctuate with dense rhythm the refined print presented for the Bodrum, the barré solution dyed outdoor decorative fabric.

I O T.S A.F



BRISTOL

1B4K004 - Col. 601
145 CM - 57 IN
90% PP - 10% PC

Un gioco di bianchi e neri, evocativo di illusioni ottiche all'origine dei macro-intrecci ortogonali che ritmano la fantasia bicolore di Bristol, il tessuto decorativo outdoor geometrico tinto in massa.

A play of black and white, evocative of optical illusions at the origin of orthogonal macro-weaves giving rhythm to two-tone print for Bristol, the solution dyed geometric outdoor decorative fabric.

NEW YORK

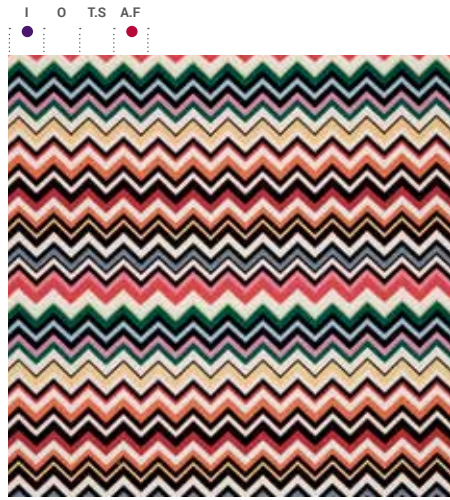

BELFAST

1B4Q023 - Col. 100

140 CM - 55 IN
100% PL

Riattualizza l'elemento grafico più iconico, lo chevron, declinandolo in una variante di sorprendente modernità, la texture multicolore di Belfast, il tessuto decorativo jacquard tinto in filo flame retardant.

Updates the most iconic graphic element, the chevron, presenting it in a surprisingly modern variation, the multi-colour texture of Belfast, the jacquard decorative fabric in flame-retardant dyed yarn.

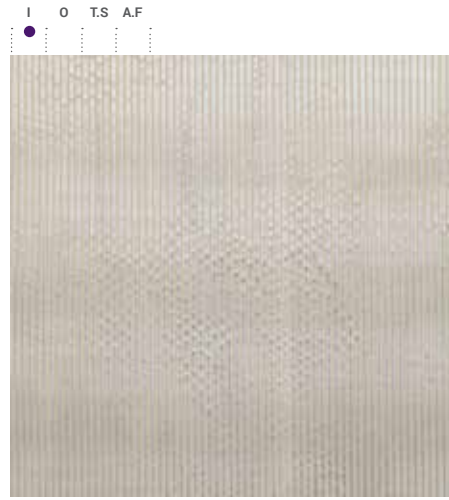

COOMBA

1H4PK03 - Col. 21

140 CM - 55 IN
62% VI - 38% CO

Si riveste di morbide scanalature che giocano con l'aspetto scultoreo dato dall'alternanza di pieni e di vuoti Coomba, il tessuto decorativo in velluto a coste tinto in pezza a effetto stropicciato.

Covered in soft grooves that play with the sculptural look given by the alternating of solids and hollows is the Coomba, in wrinkled effect dyed ribbed velvet decorative fabric.

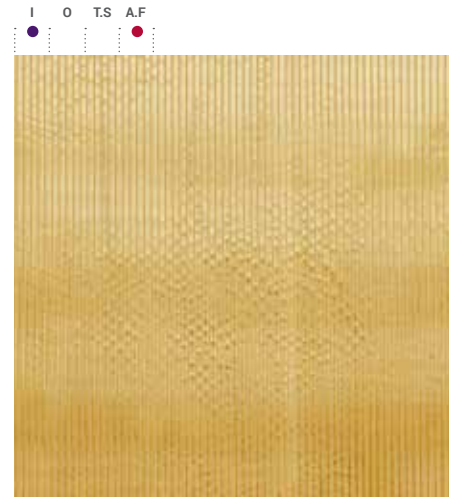

COOMBA

1H4PK03 - Col. T40

140 CM - 55 IN
62% VI - 38% CO

Si riveste di morbide scanalature che giocano con l'aspetto scultoreo dato dall'alternanza di pieni e di vuoti Coomba, il tessuto decorativo in velluto a coste tinto in pezza a effetto stropicciato.

Covered in soft grooves that play with the sculptural look given by the alternating of solids and hollows is the Coomba, in wrinkled effect dyed ribbed velvet decorative fabric.



COOMBA

1H4PK03 - Col. T56

140 CM - 55 IN
62% VI - 38% CO

Si riveste di morbide scanalature che giocano con l'aspetto scultoreo dato dall'alternanza di pieni e di vuoti Coomba, il tessuto decorativo in velluto a coste tinto in pezza a effetto stropicciato.

Covered in soft grooves that play with the sculptural look given by the alternating of solids and hollows is the Coomba, in wrinkled effect dyed ribbed velvet decorative fabric.

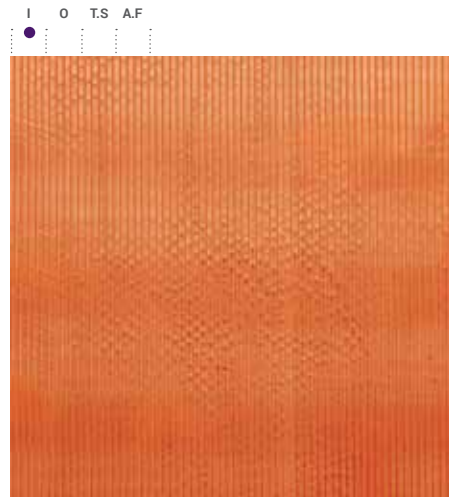

COOMBA

1H4PK03 - Col. T59

140 CM - 55 IN
62% VI - 38% CO

Si riveste di morbide scanalature che giocano con l'aspetto scultoreo dato dall'alternanza di pieni e di vuoti Coomba, il tessuto decorativo in velluto a coste tinto in pezza a effetto stropicciato.

Covered in soft grooves that play with the sculptural look given by the alternating of solids and hollows is the Coomba, in wrinkled effect dyed ribbed velvet decorative fabric.

MUSTHAVE ICONS

MUSTHAVE ICONS



MASULEH

1M4Q053 - Col. 170

145 CM - 57 IN
45% PL - 42% AC - 13% SE

Tutto il dinamismo di accostamenti cromatici decisi, inseriti in una ritmata teoria di chevron, per la texture dai toni dégradé di Masuleh, il tessuto decorativo jacquard tinto in filo.

All the vitality of clear chromatic pairings, inserted in a rhythmic chevron weave, for the texture with the fading tones of the Masuleh, the dyed yarn jacquard decorative fabric.

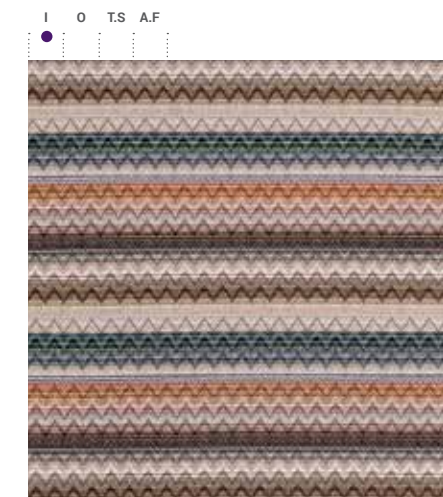

YATE

1Y4Q026 - Col. 164

140 CM - 55 IN
100% PL

Tutto il dinamismo di accostamenti cromatici decisi, inseriti in una ritmata teoria di chevron, per la texture dai toni dégradé di Yate, il tessuto decorativo jacquard tinto in filo.

All the vitality of clear chromatic pairings, inserted in a rhythmic chevron weave, for the texture with the fading tones of the Yate, the dyed yarn jacquard decorative fabric.

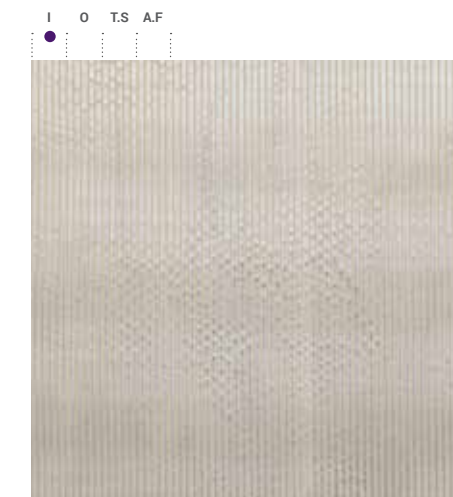

COOMBA

1H4PK03 - Col. 21

140 CM - 55 IN
62% VI - 38% CO

Si riveste di morbide scanalature che giocano con l'aspetto scultoreo dato dall'alternanza di pieni e di vuoti Coomba, il tessuto decorativo in velluto a coste tinto in pezza a effetto stropicciato.

Covered in soft grooves that play with the sculptural look given by the alternating of solids and hollows is the Coomba, in wrinkled effect dyed ribbed velvet decorative fabric.

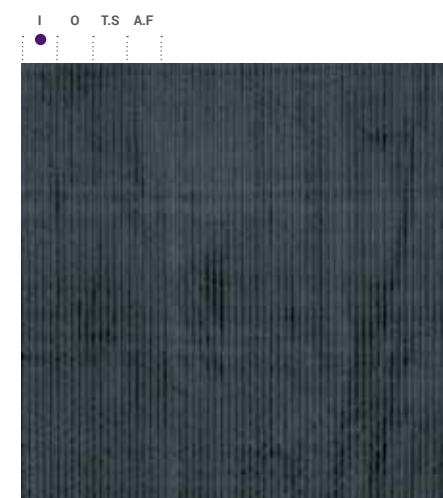

COOMBA

1H4PK03 - Col. 86

140 CM - 55 IN
62% VI - 38% CO

Si riveste di morbide scanalature che giocano con l'aspetto scultoreo dato dall'alternanza di pieni e di vuoti Coomba, il tessuto decorativo in velluto a coste tinto in pezza a effetto stropicciato.

Covered in soft grooves that play with the sculptural look given by the alternating of solids and hollows is the Coomba, in wrinkled effect dyed ribbed velvet decorative fabric.

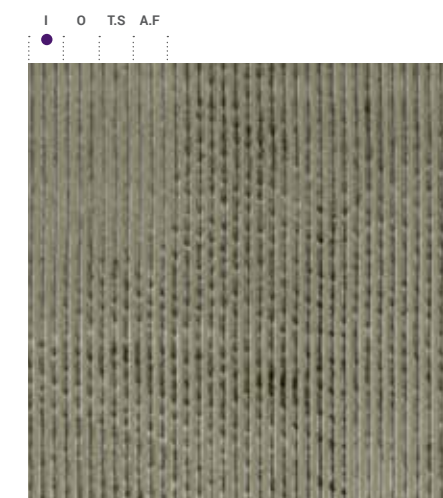

RABAT

1R4Q018 - Col. 72

135 CM - 53 IN
62% VI - 38% CO

Si riveste di morbide scanalature che giocano con l'aspetto scultoreo dato dall'alternanza di pieni e di vuoti Rabat, il tessuto decorativo in velluto a coste tinto in pezza a effetto stropicciato.

Covered in soft grooves that play with the sculptural look given by the alternating of solids and hollows is the Rabat, in wrinkled effect dyed ribbed velvet decorative fabric.

MUSTHAVE POP

MUSTHAVE POP

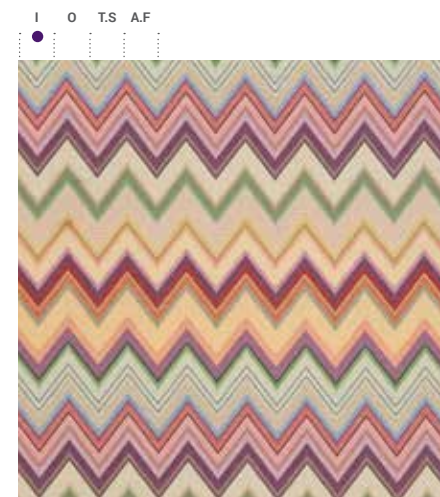

AGADIR

1A4Q019 - Col. 159

140 CM - 55 IN
76% CO - 24% PL

Tutto il dinamismo di accostamenti cromatici decisi, inseriti in una ritmata teoria di chevron, per la texture dai toni dégradé di Agadir, il tessuto decorativo jacquard tinto in filo.

All the vitality of clear chromatic pairings, inserted in a rhythmic chevron weave, for the texture with the fading tones of the Agadir, the dyed yarn jacquard decorative fabric.

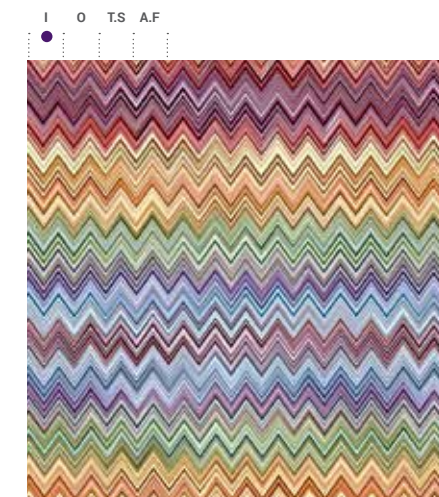

JARRIS

1J4RC55 - Col. 156

140 CM - 55 IN
100% CO

Tutto il dinamismo di accostamenti cromatici decisi, inseriti in una ritmata teoria di chevron, per la texture dai toni dégradé di Jarris, il tessuto decorativo stampato.

All the vitality of clear chromatic pairings, inserted in a rhythmic chevron weave, for the texture with the fading tones of the Jarris, the printed decorative fabric.

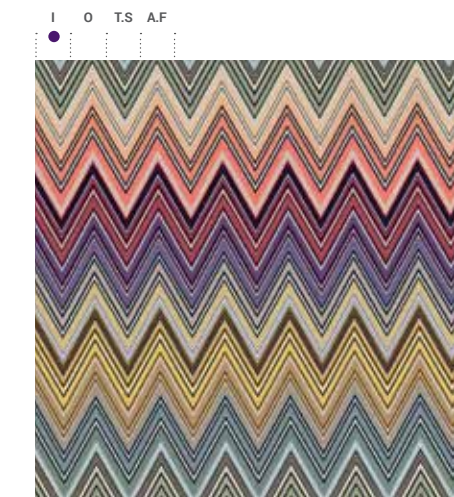

KEW

1I4Q016 - Col. T59

150 CM - 59 IN
61% CO - 29% PL - 10% SE

Tutto il dinamismo di accostamenti cromatici decisi, inseriti in una ritmata teoria di chevron, per la texture dai toni dégradé di Kew, il tessuto decorativo jacquard tinto in filo.

All the vitality of clear chromatic pairings, inserted in a rhythmic chevron weave, for the texture with the fading tones of the Kew, the dyed yarn jacquard decorative fabric.



COOMBA

1H4PK03 - Col. T57

140 CM - 55 IN
62% VI - 38% CO

Si riveste di morbide scanalature che giocano con l'aspetto scultoreo dato dall'alternanza di pieni e di vuoti Coomba, il tessuto decorativo in velluto a coste tinto in pezza a effetto stropicciato.

Covered in soft grooves that play with the sculptural look given by the alternating of solids and hollows is the Coomba, in wrinkled effect dyed ribbed velvet decorative fabric.

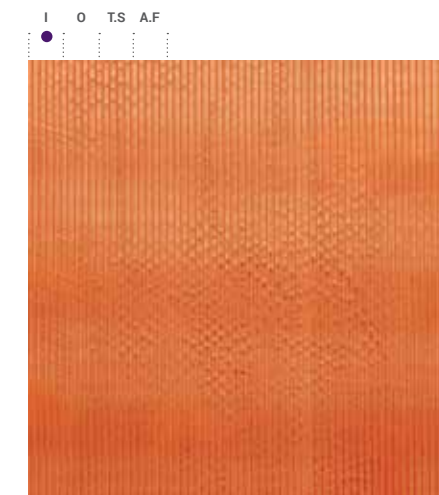

COOMBA

1H4PK03 - Col. T59

140 CM - 55 IN
62% VI - 38% CO

Si riveste di morbide scanalature che giocano con l'aspetto scultoreo dato dall'alternanza di pieni e di vuoti Coomba, il tessuto decorativo in velluto a coste tinto in pezza a effetto stropicciato.

Covered in soft grooves that play with the sculptural look given by the alternating of solids and hollows is the Coomba, in wrinkled effect dyed ribbed velvet decorative fabric.



COOMBA

1H4PK03 - Col. T65

140 CM - 55 IN
62% VI - 38% CO

Si riveste di morbide scanalature che giocano con l'aspetto scultoreo dato dall'alternanza di pieni e di vuoti Coomba, il tessuto decorativo in velluto a coste tinto in pezza a effetto stropicciato.

Covered in soft grooves that play with the sculptural look given by the alternating of solids and hollows is the Coomba, in wrinkled effect dyed ribbed velvet decorative fabric.

INDOOR



INDOOR



ACONCAGUA

1A4Q003 - Col. 100

140 CM - 55 IN
35% PL - 34% AC - 27% PA - 4% PC

Jacquard tinto in filo, fantasia di microincrespature sfumate nei toni del mare e dei coralli.

Yarn-dyed jacquard fabric with a blurred micro, ripple pattern, in the hues of the sea and coral.



AGADIR

1A4Q019 - Col. 159

140 CM - 55 IN
76% CO - 24% PL

Jacquard misto cotone, a grandi chevron nei toni pastello.

Cotton-blend jacquard fabric, with macro chevron pattern in pastel tones.



AGUNG

1A4Q017 - Col. 121

140 CM - 55 IN
100% PL

Jacquard tinto in filo Trevira CS, motivo foresta pittorica.

Yarn-dyed jacquard fabric Trevira CS, pictorial forest motif.

A.F



AMBON

1A4Q009 - Col. 121

140 CM - 55 IN
100% PL

Jacquard tinto filo Trevira CS, motivo chevron.

Yarn-dyed jacquard fabric Trevira CS, chevron motif.

A.F



AMBON

1A4Q009 - Col. 186

140 CM - 55 IN
100% PL

Jacquard tinto filo Trevira CS, motivo chevron.

Yarn-dyed jacquard Trevira CS fabric, chevron motif.

A.F



ANDAMANE

1A4Q010 - Col. 100

140 CM - 55 IN
100% PL

Jacquard tinto filo Trevira CS, maxi motivo chevron.

Yarn-dyed jacquard Trevira CS fabric, maxi chevron motif.

A.F



AGUNG

1A4Q017 - Col. 186

140 CM - 55 IN
100% PL

Jacquard tinto in filo Trevira CS, motivo foresta pittorica.

Yarn-dyed jacquard fabric Trevira CS, pictorial forest motif.

A.F



ALBANY

1A4Q015 - Col. 100

135 CM - 53 IN
92% VI - 8% PL

Velluto di viscosa tinto in filo, a righe alternate multicolori e nere.

Yarn-dyed viscose velvet with alternating black & white and multicolored stripes.

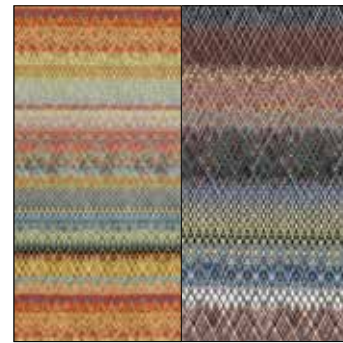

ALBERTA

1A4Q001 - Col. 164 / 164R

150 CM - 59 IN
100% PL

Jacquard tinto filo, motivo chevron grafico.

Yarn-dyed jacquard fabric, graphic chevron motif.

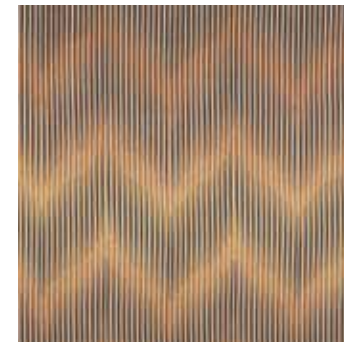

ANDE

1A4Q004 - Col. 162

130 CM - 51 IN
65% PL - 23% PC - 12% WO

Jacquard tinto filo, motivo chevron sfumato.

Yarn-dyed jacquard shaded chevron motif.

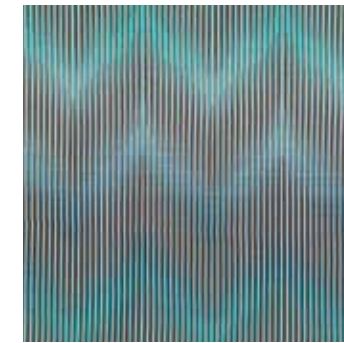

ANDE

1A4Q004 - Col. 174

130 CM - 51 IN
65% PL - 23% PC - 12% WO

Jacquard tinto filo, motivo chevron sfumato.

Yarn-dyed jacquard shaded chevron motif.



ANNAPOLIS

1A4R001 - Col. 100 / 100R

135 CM - 53 IN
63% CO - 37% LI

Canvas misto lino-cotone a righe policrome.

Double cotton-linen blend fabric with polycrome striped motif.



ALICE

1H4RC46 - Col. T50

140 CM - 55 IN
100% CO

Reps di cotone stampato a macro corolle di passiflora.

Cotton printed repps, with floral print.



ALICE

1H4RC46 - Col. T59

140 CM - 55 IN
100% CO

Reps di cotone stampato a macro corolle di passiflora.

Cotton printed repps, with floral print.



AMARILLO

1A4Q008 - Col. 100

130 CM - 51 IN
61% PL - 16% CO - 14% AC - 8% PC - 1% SE

Jacquard tinto in filo, effetto pizzo.

Yarn-dyed jacquard fabric, lace effect.



ANVERSA

1A4Q014 - Col. 159

135 CM - 53 IN
92% VI - 8% PL

Velluto di viscosa a righe multicolori, effetto degradé.

Viscose velvet with multicolored stripes, degradé effect.

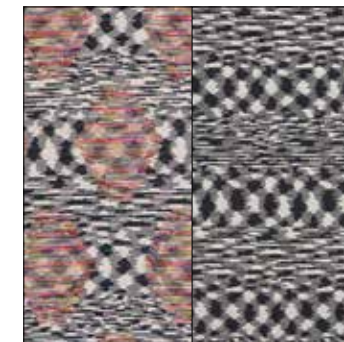

ARKANSAS

1A4Q020 - Col. 100 / 100R

140 CM - 55 IN
55% PL - 36% CO - 5% PC - 4% WO

Jacquard tinto filo double, con losanghe fil coupé, effetto tweed.

Double Yarn-dyed jacquard fabric with fil coupé lozenges, tweed effect.



ARRAS

1A4Q012 - Col. 100

140 CM - 55 IN
100% PL

Jacquard tinto filo flame retardant, motivo chevron.

Yarn-dyed flame retardant jacquard, chevron motif.

A.F

INDOOR



A.F.

AUSTRALIA

1A4Q011 - Col. 211

140 CM - 55 IN
100% PL

Jacquard tinto filo flame retardant, motivo chevron bitonale.

Yarn-dyed flame retardant jacquard, bi-tonal chevron motif.



A.F.

AUSTRALIA

1A4Q011 - Col. 601

140 CM - 55 IN
100% PL

Jacquard tinto filo flame retardant, motivo chevron bitonale.

Yarn-dyed flame retardant jacquard, bi-tonal chevron motif.



A.F.

AUSTRALIA

1A4Q011 - Col. 741

140 CM - 55 IN
100% PL

Jacquard tinto filo flame retardant, motivo chevron bitonale.

Yarn-dyed flame retardant jacquard, bi-tonal chevron motif.



BARACOA NEW

1B4P002 - Col. 59

135 CM - 53 IN
57% VI - 43% CO

Jacquard tinto pezza unito, effetto ciniglia.

Piece dyed plain jacquard, chenille effect.



BARBUDA NEW

1B4Q009 - Col. 100

140 CM - 55 IN
45% PL - 20% PC - 20% WO - 14% CO - 1% AF

Jacquard tinto filo, motivo patchwork di punti maglia.

Yarn-dyed jacquard, knit patchwork effect.



BASEL NEW

1B4P001 - Col. 22

140 CM - 55 IN
100% CO

Velluto di cotone tinto, motivo maxi Chevron.

Dyed cotton velvet, maxi chevron motif.



BAKU NEW

1B4Q010 - Col. 149 / 149R

135 CM - 53 IN
74% PL - 16% CO - 8% PC - 2% AC

Jacquard tinto filo, effetto rashed double face.

Double Yarn-dyed jacquard, rashed effect



BANFF NEW

1B4Q014 - Col. 159

140 CM - 55 IN
46% PC - 15% PL - 15% WO - 14% VI - 10% AF

Tinto filo materico, motivo sfumato.

Yarn-dyed material fabric, shaded motif.



BANGALORE NEW

1B4R004 - Col. 159

155 CM - 61 IN
100% PL

Ecopelliccia stampata.

Printed faux fur.

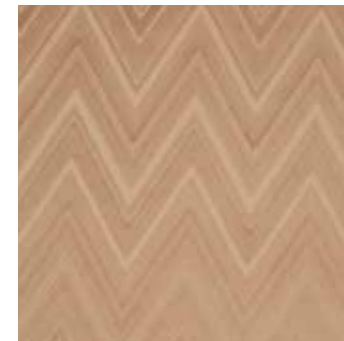

BASEL NEW

1B4P001 - Col. 48

140 CM - 55 IN
100% CO

Velluto di cotone tinto, motivo maxi Chevron.

Dyed cotton velvet, maxi chevron motif.



BASEL NEW

1B4P001 - Col. 62

140 CM - 55 IN
100% CO

Velluto di cotone tinto, motivo maxi Chevron.

Dyed cotton velvet, maxi chevron motif.



A.F.

BASTIA NEW

1B4Q004 - Col. 148

140 CM - 55 IN
100% PL

Jacquard tinto filo Trevira CS, motivo chevron.

Yarn-dyed jacquard Trevira CS, chevron motif.



BANGOR NEW

1B4Q022 - Col. 159

135 CM - 53 IN
92% VI - 8% PL

Velluto jacquard tinto filo, rigato.

Yarn-dyed velvet jacquard, striped motif.



BARACOA NEW

1B4P002 - Col. 21

135 CM - 53 IN
57% VI - 43% CO

Jacquard tinto pezza unito, effetto ciniglia.

Piece dyed plain jacquard, chenille effect.



BARACOA NEW

1B4P002 - Col. 40

135 CM - 53 IN
57% VI - 43% CO

Jacquard tinto pezza unito, effetto ciniglia.

Piece dyed plain jacquard, chenille effect.



BAYAHIBE NEW

1B4Q019 - Col. 100

135 CM - 53 IN
80% VI - 10% CO - 10% PL

Velluto jacquard tinto filo, motivo geometrico.

Yarn-dyed velvet jacquard, geometrical motif.

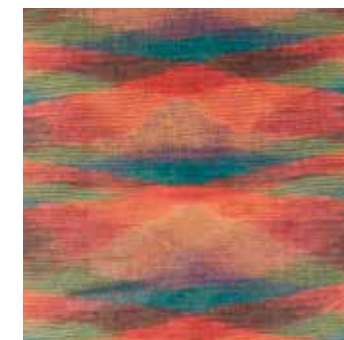

BEAUMONT NEW

1B4R003 - Col. 159

155 CM - 61 IN
100% PL

Ecopelliccia stampata.

Printed faux fur.



BEKASI NEW

1B4Q016 - Col. 149

145 CM - 57 IN
78% PL - 22% CO

Jacquard tinto filo, motivo melagrana.

Yarn-dyed jacquard with pomegranate motif.

INDOOR



BELEM NEW
1B4R001 - Col. 160
145 CM - 57 IN
100% CO

Raso di cotone stampato, motivo floreale grafico.
Cotton satin with graphic flowers.



BELFAST NEW
1B4Q023 - Col. 100
140 CM - 55 IN
100% PL

Jacquard tinto filo Trevira CS, motivo chevron.
Yarn-dyed jacquard Trevira CS, chevron motif.

A.F.

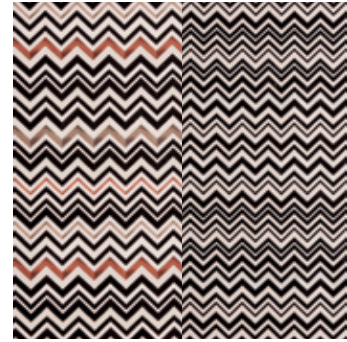

BELFAST NEW
1B4Q023 - Col. 160 / 160R
140 CM - 55 IN
100% PL

Jacquard tinto filo Trevira CS, motivo chevron double face.
Yarn-dyed reversible jacquard Trevira CS, chevron motif.

A.F.



BILLINGS NEW
1B4Q001 - Col. 159
140 CM - 55 IN
78% VI - 22% PL

Jacquard tinto filo, motivo chevron.
Yarn-dyed jacquard, chevron motif.

INDOOR



BIRMINGHAM NEW
1B4Q021 - Col. 157
140 CM - 55 IN
100% PL

Jacquard tinto filo Trevira CS, motivo chevron.
Yarn-dyed jacquard Trevira CS, chevron motif.

A.F.



BIRMINGHAM NEW
1B4Q021 - Col. 160
140 CM - 55 IN
100% PL

Jacquard tinto filo Trevira CS, motivo chevron.
Yarn-dyed jacquard Trevira CS, chevron motif.

A.F.



BERGEN NEW
1B4Q018 - Col. 481
140 CM - 55 IN
45% LI - 27% VI - 26% PL - 2% PA

Jacquard tinto filo, motivo chevron bitonale.
Yarn-dyed jacquard, bi-tonal chevron motif.



BERGEN NEW
1B4Q018 - Col. 601
140 CM - 55 IN
45% LI - 27% VI - 26% PL - 2% PA

Jacquard tinto filo, motivo chevron bitonale.
Yarn-dyed jacquard, bi-tonal chevron motif.



BERGERAC NEW
1B4Q003 - Col. 62
140 CM - 55 IN
66% VI - 34% PL

Velluto di viscosa tinto filo, effetto raschel.
Yarn-dyed viscose velvet, raschel effect.

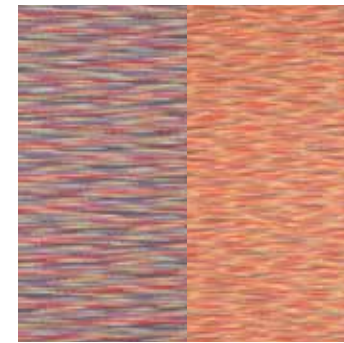

BISCAYNE NEW
1B4Q002 - Col. 159 / 159R
140 CM - 55 IN
70% VI - 30% PL

Jacquard tinto filo, effetto maglia fiammato double face.
Yarn-dyed jacquard Trevira CS, chevron motif.



BOUGAINVILLE NEW
1B4Q006 - Col. 149 / 149R
140 CM - 55 IN
55% PL - 23% WO - 20% AR - 2% PA

Jacquard tinto filo stampato bouclé, motivo floreale double face.
Yarn-dyed printed bouclé reversible jacquard, floral motif.



BOULDER NEW
1B4Q013 - Col. 159
145 CM - 57 IN
35% CO - 32% WO - 31% PL - 2% PA

Scozzese tinto filo.
Yarn-dyed tartan fabric.

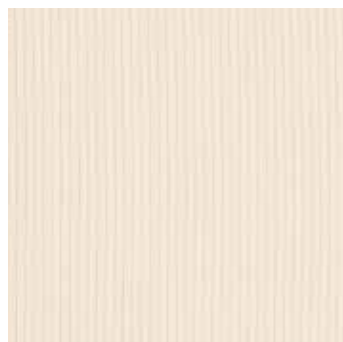

BERN NEW
1B4Q015 - Col. 21
135 CM - 53 IN
52% PC - 22% WO - 17% CO - 5% PL - 4% AF

Jacquard tinto filo, effetto maglia.
Yarn-dyed jacquard, knit effect.



BHUTAN NEW
1B4Q017 - Col. 149
145 CM - 57 IN
93% PL - 7% PA

Jacquard tinto filo, motivo astratto.
Yarn-dyed jacquard, abstract motif.



BIARRITZ NEW
1B4R002 - Col. 148
140 CM - 55 IN
100% PL

Velluto stampato Trevira CS, motivo floreale.
Printed velvet Trevira CS, floral motif.

A.F.

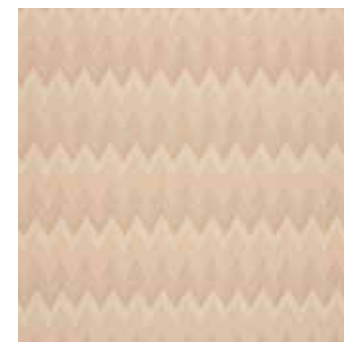

BREST NEW
1B4Q005 - Col. 481
140 CM - 55 IN
100% PL

Jacquard tinto filo Trevira CS, motivo chevron.
Yarn-dyed reversible jacquard Trevira CS, chevron motif.

A.F.



BREST NEW
1B4Q005 - Col. 861
140 CM - 55 IN
100% PL

Jacquard tinto filo Trevira CS, motivo chevron.
Yarn-dyed reversible jacquard Trevira CS, chevron motif.

A.F.



BRIDGETOWN NEW
1B4Q008 - Col. 481
140 CM - 55 IN
70% WO - 20% PA - 10% PL

Jacquard tinto filo effetto feltro, motivo chevron.
Yarn-dyed felt effect jacquard, chevron motif.

INDOOR



BRIDGETOWN NEW

1B4Q008 - Col. 611

140 CM - 55 IN
70% WO - 20% PA - 10% PL

Jacquard tinto filo effetto feltro, motivo chevron.
Yarn-dyed felt effect jacquard, chevron motif.



BRIGHTON NEW

1B4Q020 - Col. 157

145 CM - 57 IN
100% PL

Jacquard tinto filo Trevira CS, motivo rigato barré.
Yarn-dyed jacquard Trevira CS, striped barré motif.

A.F. ●



BRIGHTON NEW

1B4Q020 - Col. 160

145 CM - 57 IN
100% PL

Jacquard tinto filo Trevira CS, motivo rigato barré.
Yarn-dyed jacquard Trevira CS, striped barré motif.

A.F. ●



COOMBA

1H4PK03 - Col. 21

140 CM - 55 IN
62% VI - 38% CO

Velluto di viscosa tinta unita a macro coste.
Solid colour velvet in wide-ribbed viscose.



COOMBA

1H4PK03 - Col. 62

140 CM - 55 IN
62% VI - 38% CO

Velluto di viscosa tinta unita a macro coste.
Solid colour velvet in wide-ribbed viscose.



COOMBA

1H4PK03 - Col. 86

140 CM - 55 IN
62% VI - 38% CO

Velluto di viscosa tinta unita a macro coste.
Solid colour velvet in wide-ribbed viscose.



BROOKLYN NEW

1B4Q007 - Col. 159

140 CM - 55 IN
38% PC - 38% WO - 14% PA - 10% PL

Jacquard tinto filo bouclé stampato, motivo logo.
Yarn-dyed printed bouclé jacquard, logo print.

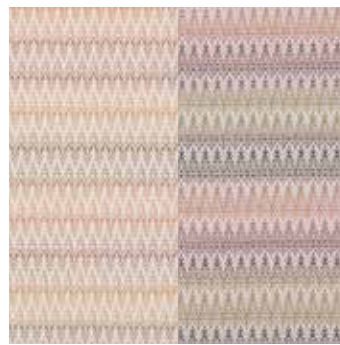

BRUGES NEW

1B4Q011 - Col. 148 / 148R

130 CM - 51 IN
47% CO - 38% PL - 10% PC - 5% PM

Jacquard tinto filo con lurex, effetto raschel double face.
Yarn-dyed reversible jacquard with lurex, raschel effect.



BRUNEI NEW

1B4Q012 - Col. 149

140 CM - 55 IN
45% VI - 41% CO - 10% PC - 4% PL

Jacquard tinto filo, motivo chevron sfumato.
Yarn-dyed reversible jacquard, shaded chevron motif.



COOMBA

1H4PK03 - Col. T40

140 CM - 55 IN
62% VI - 38% CO

Velluto di viscosa tinta unita a macro coste.
Solid colour velvet in wide-ribbed viscose.



COOMBA

1H4PK03 - Col. T49

140 CM - 55 IN
62% VI - 38% CO

Velluto di viscosa tinta unita a macro coste.
Solid colour velvet in wide-ribbed viscose.



COOMBA

1H4PK03 - Col. T56

140 CM - 55 IN
62% VI - 38% CO

Velluto di viscosa tinta unita a macro coste.
Solid colour velvet in wide-ribbed viscose.



CARTAGENA

1G4RC41 - Col. T20

140 CM - 55 IN
100% CO

Jacquard tinto in filo barré.
Jacquard fabric with blended multicolour stripe motif.



CLAREMONT

114QU44 - Col. T59

150 CM - 59 IN
62% PL - 21% CO - 17% SE

Jacquard tinto in filo barré.
Jacquard fabric with blended multicolour stripe motif.



CLAREMONT

114QU44 - Col. 170

150 CM - 59 IN
62% PL - 21% CO - 17% SE

Jacquard tinto in filo barré.
Jacquard fabric with blended multicolour stripe motif.



COOMBA

1H4PK03 - Col. T57

140 CM - 55 IN
62% VI - 38% CO

Velluto di viscosa tinta unita a macro coste.
Solid colour velvet in wide-ribbed viscose.



COOMBA

1H4PK03 - Col. T59

140 CM - 55 IN
62% VI - 38% CO

Velluto di viscosa tinta unita a macro coste.
Solid colour velvet in wide-ribbed viscose.



COOMBA

1H4PK03 - Col. T65

140 CM - 55 IN
62% VI - 38% CO

Velluto di viscosa tinta unita a macro coste.
Solid colour velvet in wide-ribbed viscose.

INDOOR

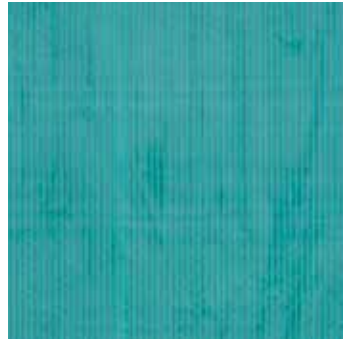

COOMBA

1H4PK03 - Col. T70

140 CM - 55 IN
62% VI - 38% CO

Velluto di viscosa tinta unita a macro coste.
Solid colour velvet in wide-ribbed viscose.

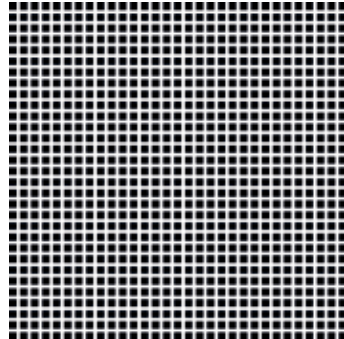

GSTAAD

1F4QC28 - Col. T60

140 CM - 55 IN
100% CO

Jacquard tinto filo, effetto tridimensionale.
Yarn-dyed 3D effect jacquard.



JACARANDA

1H4QK19 - Col. T50

135 CM - 53 IN
92% VI - 8% PL

Velluto di viscosa jacquard a sfumature alternate.
Jacquard viscose velvet with design in alternating shades.



JENKINS

1J4QA11 - Col. 150

140 CM - 55 IN
100% CO

Raso di cotone, stampa millerighe multicolori.
Cotton satin with a multicolour blended stripes print.



JENKINS

1J4QA11 - Col. 156

140 CM - 55 IN
100% CO

Raso di cotone, stampa millerighe multicolori.
Cotton satin with a multicolour blended stripes print.



JERSEY

1J4RC54 - Col. 148

140 CM - 55 IN
100% CO

Raso di cotone stampato, motivo floreale.
Cotton satin printed fabric with floral motif.



JACARANDA

1H4QK19 - Col. T59

135 CM - 53 IN
92% VI - 8% PL

Velluto di viscosa jacquard a sfumature alternate.
Jacquard viscose velvet with design in alternating shades.



JACARANDA

1H4QK19 - Col. T60

135 CM - 53 IN
92% VI - 8% PL

Velluto di viscosa jacquard a sfumature alternate.
Jacquard viscose velvet with design in alternating shades.



JARRIS

1J4RC55 - Col. 148

140 CM - 55 IN
100% CO

Raso di cotone stampato, a chevron multicolori.
Cotton satin with a multicolour zigzag print.



JERSEY

1J4RC54 - Col. 156

140 CM - 55 IN
100% CO

Raso di cotone stampato, motivo floreale.
Cotton satin printed fabric with floral motif.



KEW

114QO16 - Col. 170

150 CM - 59 IN
61% CO - 29% PL - 10% SE

Jacquard tinto in filo, nell'iconico macro chevron multicolore.
Jacquard fabric with the iconic multicolour macro chevron motif.



KEW

114QO16 - Col. T59

150 CM - 59 IN
61% CO - 29% PL - 10% SE

Jacquard tinto in filo, nell'iconico macro chevron multicolore.
Jacquard fabric with the iconic multicolour macro chevron motif.



JARRIS

1J4RC55 - Col. 150

140 CM - 55 IN
100% CO

Raso di cotone stampato, a chevron multicolori.
Cotton satin with a multicolour zigzag print.



JARRIS

1J4RC55 - Col. 156

140 CM - 55 IN
100% CO

Raso di cotone stampato, a chevron multicolori.
Cotton satin with a multicolour zigzag print.

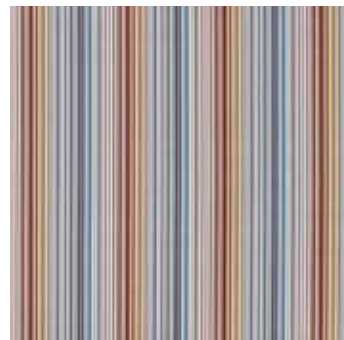

JENKINS

1J4QA11 - Col. 148

140 CM - 55 IN
100% CO

Raso di cotone, stampa millerighe multicolori.
Cotton satin with a multicolour blended stripes print.



KIGALI

1K4QK22 - Col. 149

135 CM - 53 IN
100% VI

Velluto jacquard tinto filo, motivo optical.
Yarn-dyed velvet jacquard striped optical motif.



KIGALI

1K4QK22 - Col. 170

135 CM - 53 IN
100% VI

Velluto jacquard tinto filo, motivo optical.
Yarn-dyed velvet jacquard striped optical motif.



KYOTO

1K4RC60 - Col. 159

145 CM - 57 IN
100% CO

Raso di cotone stampato, motivo floreale grafico.
Cotton satin printed fabric with graphic floral motif.

INDOOR



LIBERTAD

1L4QK24 - Col. 140
135 CM - 53 IN
100% VI

Velluto jacquard tinto filo, rigato.
Yarn-dyed velvet jacquard striped motif.



LIBERTAD

1L4QK24 - Col. 159
135 CM - 53 IN
100% VI

Velluto jacquard tinto filo, rigato.
Yarn-dyed velvet jacquard striped motif.



LOBELIA

1L4RC68 - Col. 140
145 CM - 57 IN
100% CO

Raso effetto dama stampato, motivo floreale.
Printed checkers satin with floral motif.



MASULEH

1M4Q053 - Col. 156
145 CM - 57 IN
45% PL - 42% AC - 13% SE

Jacquard a chevron sfumati, con lurex.
Jacquard fabric and lurex with a blended chevron motif.



MASULEH

1M4Q053 - Col. 170
145 CM - 57 IN
45% PL - 42% AC - 13% SE

Jacquard a chevron sfumati, con lurex.
Jacquard fabric and lurex with a blended chevron motif.



MOOMBA

1H4QI87 - Col. T28
140 CM - 55 IN
71% VI - 25% CO - 4% PL

Twill tinto filo unito.
Yarn-dyed plain twill.



LOBELIA

1L4RC68 - Col. 159
145 CM - 57 IN
100% CO

Raso effetto dama stampato, motivo floreale.
Printed checkers satin with floral motif.



LOBOS

1L4RC69 - Col. 140
145 CM - 57 IN
100% CO

Raso damina di cotone stampato, effetto pixel.
Small printed checkers cotton satin with pixel motif.

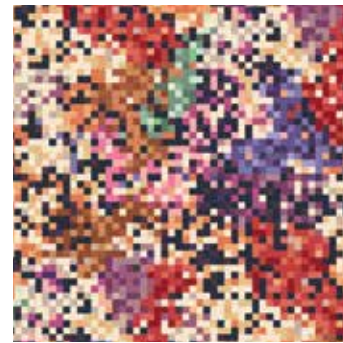

LOBOS

1L4RC69 - Col. 159
145 CM - 57 IN
100% CO

Raso damina di cotone stampato, effetto pixel.
Small printed checkers cotton satin with pixel motif.



MOOMBA

1H4QI87 - Col. T36
140 CM - 55 IN
71% VI - 25% CO - 4% PL

Twill tinto filo unito.
Yarn-dyed plain twill.



MOOMBA

1H4QI87 - Col. T38
140 CM - 55 IN
71% VI - 25% CO - 4% PL

Twill tinto filo unito.
Yarn-dyed plain twill.



MOOMBA

1H4QI87 - Col. T40
140 CM - 55 IN
71% VI - 25% CO - 4% PL

Twill tinto filo unito.
Yarn-dyed plain twill.



MASEKO

1M4QK26 - Col. 156
135 CM - 53 IN
100% VI

Velluto jacquard tinto filo, motivo quadrettato.
Yarn-dyed velvet jacquard cheched motif.



MASEKO

1M4QK26 - Col. 160
135 CM - 53 IN
100% VI

Velluto jacquard tinto filo, motivo quadrettato.
Yarn-dyed velvet jacquard cheched motif.

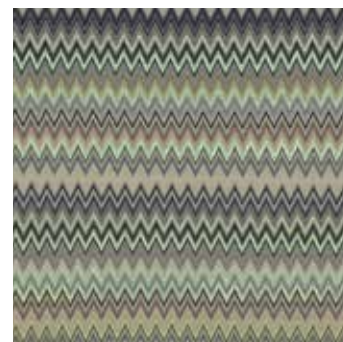

MASULEH

1M4Q053 - Col. 131
145 CM - 57 IN
45% PL - 42% AC - 13% SE

Jacquard a chevron sfumati, con lurex.
Jacquard fabric and lurex with a blended chevron motif.



MOOMBA

1H4QI87 - Col. T48
140 CM - 55 IN
71% VI - 25% CO - 4% PL

Twill tinto filo unito.
Yarn-dyed plain twill.



MOOMBA

1H4QI87 - Col. T50
140 CM - 55 IN
71% VI - 25% CO - 4% PL

Twill tinto filo unito.
Yarn-dyed plain twill.



MOOMBA

1H4QI87 - Col. T55
140 CM - 55 IN
71% VI - 25% CO - 4% PL

Twill tinto filo unito.
Yarn-dyed plain twill.

INDOOR



MOOMBA

1H4QI87 - Col. T60

140 CM - 55 IN
71% VI - 25% CO - 4% PL

Twill tinto filo unito.

Yarn-dyed plain twill.



MOOMBA

1H4QI87 - Col. T65

140 CM - 55 IN
71% VI - 25% CO - 4% PL

Twill tinto filo unito.

Yarn-dyed plain twill.

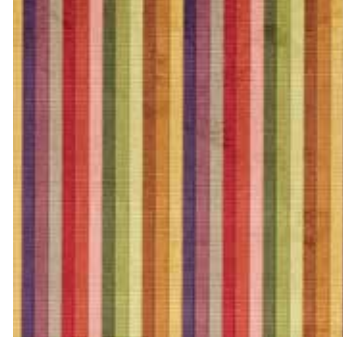

MYSORE

1M4QK25 - Col. 156

135 CM - 53 IN
100% VI

Velluto jacquard tinto filo, rigato.

Yarn-dyed velvet jacquard striped motif.



NESTEROV

1N4Q009 - Col. 170

135 CM - 53 IN
47% CO - 39% PL - 14% PA

Jacquard imbottito a macro chevron, con lurex.

Padded jacquard fabric with a macro chevron motif in lurex.

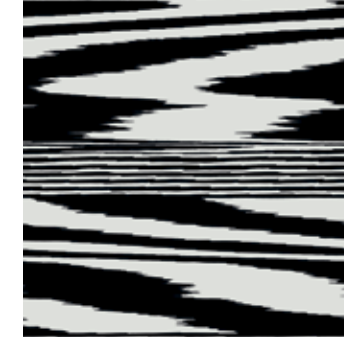

NEUSS

1N4R012 - Col. 601

140 CM - 55 IN
100% LI

Canvas di lino stampato a macro fiamma bianconera.

Linen canvas printed with a black and white flame macro motif.



NOCEDA

1N4R010 - Col. 159

145 CM - 57 IN
100% CO

Raso damina di cotone stampato, effetto optical.

Small printed checkers satin with optical motif.



MYSORE

1M4QK25 - Col. 160

135 CM - 53 IN
100% VI

Velluto jacquard tinto filo, rigato.

Yarn-dyed velvet jacquard striped motif.

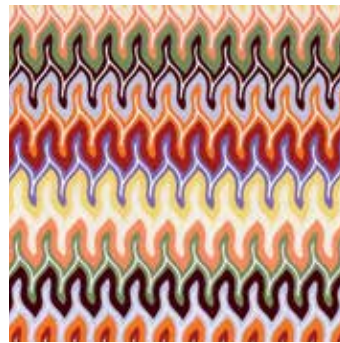

NADAUN

1N4R006 - Col. 159

140 CM - 55 IN
100% CO

Raso di cotone stampato, motivo geometrico iconico.

Cotton satin printed fabric with iconic geometrical motif.



NADOR

1N4Q004 - Col. 159

135 CM - 53 IN
79% VI - 21% CO

Velluto jacquard tinto filo, motivo chevron.

Yarn-dyed velvet jacquard chevron motif.



NOSSEN

1N4Q010 - Col. 601

135 CM - 53 IN
53% PL - 30% CO - 17% PA

Jacquard tinto filo, motivo chevron.

Yarn-dyed jacquard chevron motif.



NUH

1N4Q007 - Col. 48

135 CM - 53 IN
100% VI

Velluto jacquard tinto filo, rigato.

Yarn-dyed velvet jacquard striped motif.



NUH

1N4Q007 - Col. 59

135 CM - 53 IN
100% VI

Velluto jacquard tinto filo, rigato.

Yarn-dyed velvet jacquard striped motif.



NANCHO

1N4R004 - Col. 159

140 CM - 55 IN
63% CO - 37% LI

Canva stampata, motivo chevron effetto maglia.

Digital printed canvas chevron knitted effect.



NEDA

1N4R003 - Col. 159

140 CM - 55 IN
100% CO

Raso di cotone stampato a macro corolle di passiflora.

Cotton printed satin, with floral print.



NESTEROV

1N4Q009 - Col. 140

135 CM - 53 IN
47% CO - 39% PL - 14% PA

Jacquard imbottito a macro chevron, con lurex.

Padded jacquard fabric with a macro chevron motif in lurex.



NUH

1N4Q007 - Col. 65

135 CM - 53 IN
100% VI

Velluto jacquard tinto filo, rigato.

Yarn-dyed velvet jacquard striped motif.



NUH

1N4Q007 - Col. 70

135 CM - 53 IN
100% VI

Velluto jacquard tinto filo, rigato.

Yarn-dyed velvet jacquard striped motif.

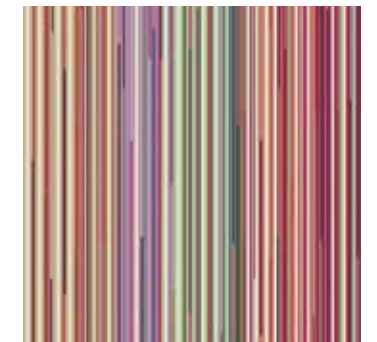

OCOEE

104Q017 - Col. 156

135 CM - 53 IN
100% PL

Velluto jacquard tinto filo Trevira CS, rigato.

Yarn-dyed velvet jacquard Trevira CS, striped motif.

A.F.

INDOOR



A.F. ●

OCOEE

104Q017 - Col. 160

135 CM - 53 IN
100% PL

Velluto jacquard tinto filo Trevira CS, rigato.
Yarn-dyed velvet jacquard Trevira CS, striped motif.



OLEG

104Q022 - Col. 100

135 CM - 53 IN
64% CO - 23% PL - 13% PC

Jacquard tinto filo sfumato, rigato.
Yarn-dyed jacquard shaded striped motif.



OLEG

104Q022 - Col. 156

135 CM - 53 IN
64% CO - 23% PL - 13% PC

Jacquard tinto filo sfumato, rigato.
Yarn-dyed jacquard shaded striped motif.

INDOOR



PASSIFLORA

1H4RC45 - Col. T50

140 CM - 55 IN
100% CO

Raso di cotone stampato a macro corolle di passiflora.
Cotton satin with floral print.



PASSIFLORA

1H4RC45 - Col. T59

140 CM - 55 IN
100% CO

Raso di cotone stampato a macro corolle di passiflora.
Cotton satin with floral print.



PASSIFLORA

1H4RC45 - Col. T60

140 CM - 55 IN
100% CO

Raso di cotone stampato a macro corolle di passiflora.
Cotton satin with floral print.



A.F. ●

OZAN

104Q012 - Col. 156

140 CM - 55 IN
100% PL

Jacquard tinto filo Trevira CS, motivo chevron.
Yarn-dyed jacquard Trevira CS, chevron motif.



A.F. ●

OZAN

104Q012 - Col. 160

140 CM - 55 IN
100% PL

Jacquard tinto filo Trevira CS, motivo chevron.
Yarn-dyed jacquard Trevira CS, chevron motif.



PAILIN

1P4Q003 - Col. 100

135 CM - 53 IN
94% PL - 6% PC

Jacquard tinto filo con lurex, motivo geometrico.
Yarn-dyed jacquard with lurex, geometric motif.



PASSIFLORA GIANT

1P4R003 - Col. 159

140 CM - 55 IN
100% CO

Raso di cotone stampato a macro corolle di passiflora.
Cotton satin with floral print.

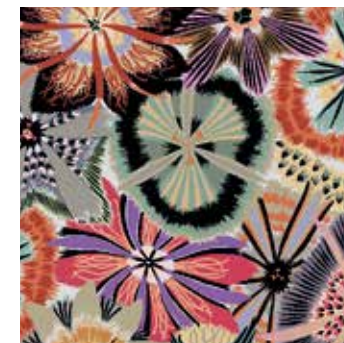

PASSIFLORA GIANT

1P4R003 - Col. 170

140 CM - 55 IN
100% CO

Raso di cotone stampato a macro corolle di passiflora.
Cotton satin with floral print.



PHRAE

1P4Q007 - Col. 100

145 CM - 57 IN
57% CO - 26% PL - 17% AC

Jacquard, motivo chevron a toni acquarellati.
Jacquard fabric with watercolour chevron effect in muted tones.



PALENQUE

1P4Q014 - Col. 100

140 CM - 55 IN
35% VI - 26% CO - 20% PL - 19% SE

Jacquard misto seta, motivo patch di righe acquarellate.
Silk-blend jacquard fabric with watercolour stripe patchwork motif.

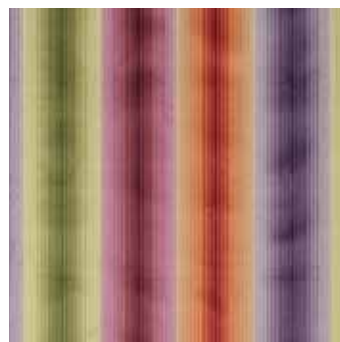

PARAGUAY

1P4Q001 - Col. 100

135 CM - 53 IN
100% VI

Velluto jacquard tinto filo sfumato, rigato.
Yarn-dyed velvet jacquard shaded striped motif.



PASADENA

1P4Q002 - Col. 100

130 CM - 51 IN
53% PL - 38% CO - 9% PC

Jacquard sfumato multicolore effetto pizzo.
Blended multicolour jacquard fabric for a lace effect.

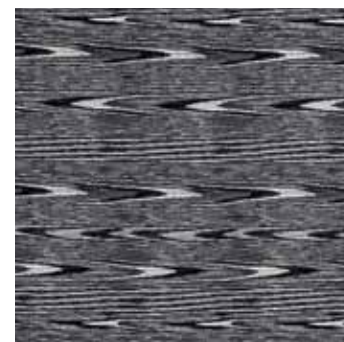

PIAUI

1P4Q019 - Col. 601

150 CM - 59 IN
69% CO - 31% PL

Jacquard tinto filo, motivo iconico fiammato bitonale.
Yarn-dyed jacquard iconic bi-tonal slub motif.

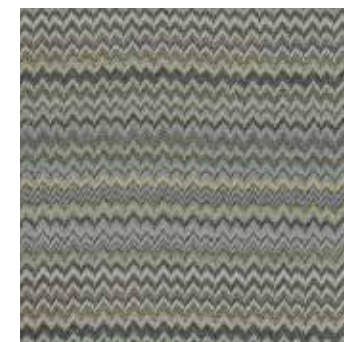

PLAISIR

1P4Q009 - Col. 170

145 CM - 57 IN
57% PL - 30% AC - 8% PA - 5% SE

Jacquard con lurex, motivo chevron sfumato.
Jacquard fabric with lurex, blended chevron motif.



PLAISIR

1P4Q009 - Col. 156

145 CM - 57 IN
57% PL - 30% AC - 8% PA - 5% SE

Jacquard con lurex, motivo chevron sfumato.
Jacquard fabric with lurex, blended chevron motif.

INDOOR



PRINCETON

1P4Q021 - Col. 100

135 CM - 53 IN
47% WO - 41% PC - 12% PL

Jacquard tinto filo, motivo chevron.
Yarn-dyed jacquard chevron motif.



RABAT

1R4Q018 - Col. 21

135 CM - 53 IN
62% VI - 38% CO

Velluto di viscosa-cotone tinto in pezza a macro coste stropicciate.
Macro-ribbed solid colour viscose-cotton velvet with creased effect.



RABAT

1R4Q018 - Col. 40

135 CM - 53 IN
62% VI - 38% CO

Velluto di viscosa-cotone tinto in pezza a macro coste stropicciate.
Macro-ribbed solid colour viscose-cotton velvet with creased effect.

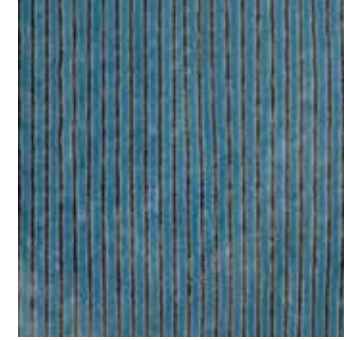

RAFAH

1R4Q015 - Col. 22

140 CM - 55 IN
68% CO - 32% VI

Velluto di cotone-viscosa, a microcoste bicolori.
Cotton-viscose velvet with two-tone micro-ribbing.

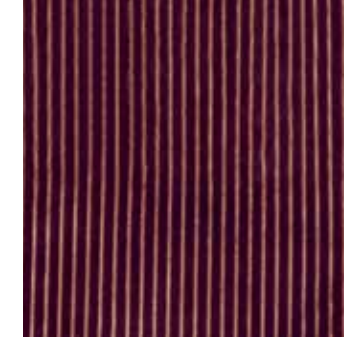

RAFAH

1R4Q015 - Col. 23

140 CM - 55 IN
68% CO - 32% VI

Velluto di cotone-viscosa, a microcoste bicolori.
Cotton-viscose velvet with two-tone micro-ribbing.

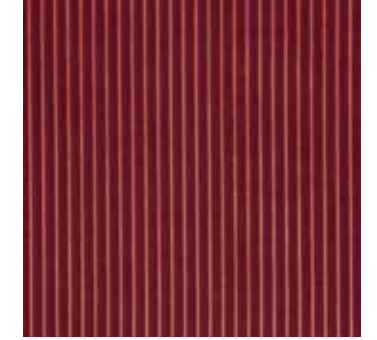

RAFAH

1R4Q015 - Col. 28

140 CM - 55 IN
68% CO - 32% VI

Velluto di cotone-viscosa, a microcoste bicolori.
Cotton-viscose velvet with two-tone micro-ribbing.



RABAT

1R4Q018 - Col. 56

135 CM - 53 IN
62% VI - 38% CO

Velluto di viscosa-cotone tinto in pezza a macro coste stropicciate.
Macro-ribbed solid colour viscose-cotton velvet with creased effect.



RABAT

1R4Q018 - Col. 60

135 CM - 53 IN
62% VI - 38% CO

Velluto di viscosa-cotone tinto in pezza a macro coste stropicciate.
Macro-ribbed solid colour viscose-cotton velvet with creased effect.



RABAT

1R4Q018 - Col. 62

135 CM - 53 IN
62% VI - 38% CO

Velluto di viscosa-cotone tinto in pezza a macro coste stropicciate.
Macro-ribbed solid colour viscose-cotton velvet with creased effect.

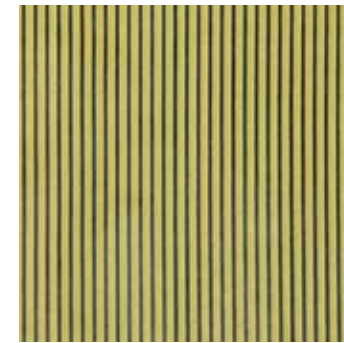

RAFAH

1R4Q015 - Col. 40

140 CM - 55 IN
68% CO - 32% VI

Velluto di cotone-viscosa, a microcoste bicolori.
Cotton-viscose velvet with two-tone micro-ribbing.

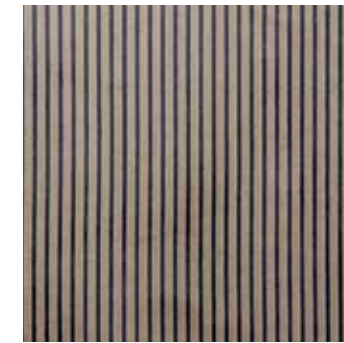

RAFAH

1R4Q015 - Col. 48

140 CM - 55 IN
68% CO - 32% VI

Velluto di cotone-viscosa, a microcoste bicolori.
Cotton-viscose velvet with two-tone micro-ribbing.

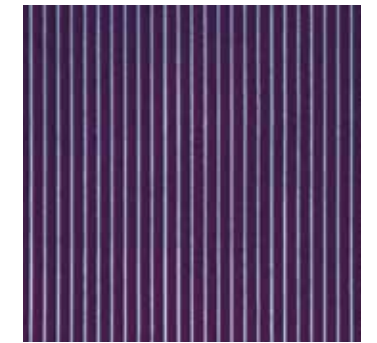

RAFAH

1R4Q015 - Col. 49

140 CM - 55 IN
68% CO - 32% VI

Velluto di cotone-viscosa, a microcoste bicolori.
Cotton-viscose velvet with two-tone micro-ribbing.

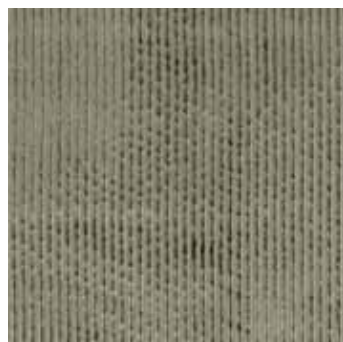

RABAT

1R4Q018 - Col. 72

135 CM - 53 IN
62% VI - 38% CO

Velluto di viscosa-cotone tinto in pezza a macro coste stropicciate.
Macro-ribbed solid colour viscose-cotton velvet with creased effect.



RABAT

1R4Q018 - Col. 74

135 CM - 53 IN
62% VI - 38% CO

Velluto di viscosa-cotone tinto in pezza a macro coste stropicciate.
Macro-ribbed solid colour viscose-cotton velvet with creased effect.



RAFAH

1R4Q015 - Col. 21

140 CM - 55 IN
68% CO - 32% VI

Velluto di cotone-viscosa, a microcoste bicolori.
Cotton-viscose velvet with two-tone micro-ribbing.



RAFAH

1R4Q015 - Col. 61

140 CM - 55 IN
68% CO - 32% VI

Velluto di cotone-viscosa, a microcoste bicolori.
Cotton-viscose velvet with two-tone micro-ribbing.

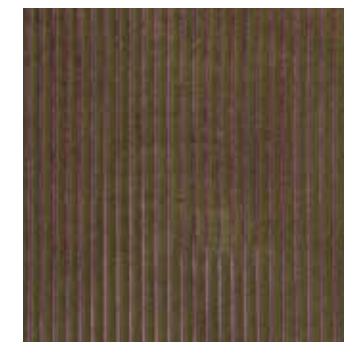

RAFAH

1R4Q015 - Col. 65

140 CM - 55 IN
68% CO - 32% VI

Velluto di cotone-viscosa, a microcoste bicolori.
Cotton-viscose velvet with two-tone micro-ribbing.

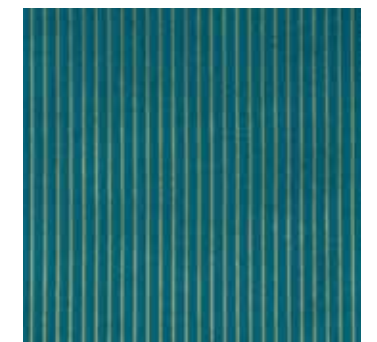

RAFAH

1R4Q015 - Col. 74

140 CM - 55 IN
68% CO - 32% VI

Velluto di cotone-viscosa, a microcoste bicolori.
Cotton-viscose velvet with two-tone micro-ribbing.

INDOOR



RAJAM

1R4Q020 - Col. 100
145 CM - 57 IN
46% PL - 42% CO - 12% PC

Jacquard tinto filo, motivo piccolo chevron.
Yarn-dyed jacquard small chevron motif.



RAMAN

1R4R006 - Col. 100
145 CM - 57 IN
100% CO

Raso effetto dama stampato, motivo floreale.
Printed checkers satin with floral motif.



RAMPUR

1R4Q017 - Col. 100
135 CM - 53 IN
100% CO

Jacquard tinto filo, motivo barrè.
Yarn-dyed barrèjacquard striped motif.



SAFI

1S4Q002 - Col. 481
140 CM - 55 IN
42% VI - 23% PL - 14% WO - 14% PC - 7% LI

Jacquard tinto in filo con motivo fiammato bicolore, effetto animalier.
Yarn-dyed jacquard fabric in a two-tone animal effect pattern.



SAFI

1S4Q002 - Col. 561
140 CM - 55 IN
42% VI - 23% PL - 14% WO - 14% PC - 7% LI

Jacquard tinto in filo con motivo fiammato bicolore, effetto animalier.
Yarn-dyed jacquard fabric in a two-tone animal effect pattern.



SAFI

1S4Q002 - Col. 591
140 CM - 55 IN
42% VI - 23% PL - 14% WO - 14% PC - 7% LI

Jacquard tinto in filo con motivo fiammato bicolore, effetto animalier.
Yarn-dyed jacquard fabric in a two-tone animal effect pattern.



RAVENNA

1R4Q001 - Col. 149
135 CM - 53 IN
100% VI

Velluto jacquard tinto filo, chevron multicolor.
Yarn-dyed velvet jacquard multicolor chevron motif.



REMICH

1R4Q016 - Col. 131
135 CM - 53 IN
61% PL - 32% PA - 7% PC

Jacquard tinto fillo, effetto raschel.
Yarn-dyed jacquard iconic russhel effect.



REMICH

1R4Q016 - Col. 140
135 CM - 53 IN
61% PL - 32% PA - 7% PC

Jacquard tinto fillo, effetto raschel.
Yarn-dyed jacquard iconic russhel effect.

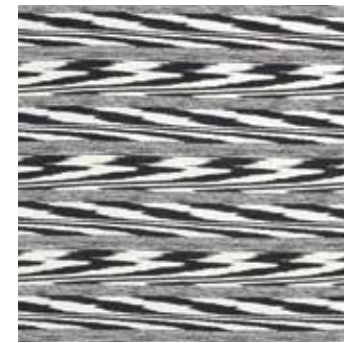

SAFI

1S4Q002 - Col. 601
140 CM - 55 IN
42% VI - 23% PL - 14% WO - 14% PC - 7% LI

Jacquard tinto in filo con motivo fiammato bicolore, effetto animalier.
Yarn-dyed jacquard fabric in a two-tone animal effect pattern.

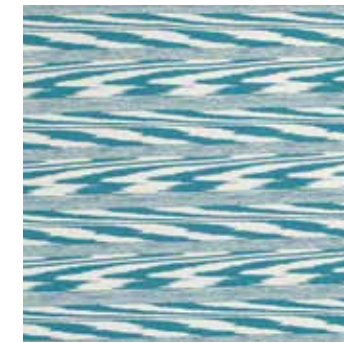

SAFI

1S4Q002 - Col. 701
140 CM - 55 IN
42% VI - 23% PL - 14% WO - 14% PC - 7% LI

Jacquard tinto in filo con motivo fiammato bicolore, effetto animalier.
Yarn-dyed jacquard fabric in a two-tone animal effect pattern.

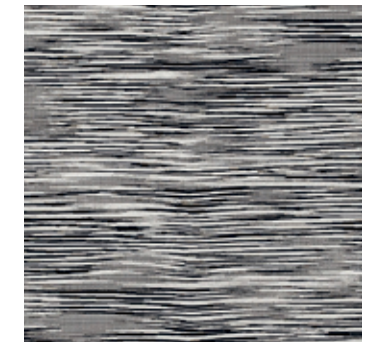

SAKAI

1S4Q015 - Col. 601
150 CM - 59 IN
46% PL - 28% CO - 26% PA

Jacquard tinto filo, motivo iconico fiammato bitonale.
Yarn-dyed jacquard iconic bi-tonal slub motif.



RENO

1R4Q019 - Col. 156
140 CM - 55 IN
60% CO - 36% VI - 4% MD

Velluto a coste stampato, rigato.
Printed corduroy velvet jacquard



ROING

1R4Q004 - Col. 100
140 CM - 55 IN
57% PL - 35% CO - 8% PC

Jacquard tinto fillo, effetto raschel.
Yarn-dyed jacquard iconic russhel effect.



SAFI

1S4Q002 - Col. 381
140 CM - 55 IN
42% VI - 23% PL - 14% WO - 14% PC - 7% LI

Jacquard tinto in filo con motivo fiammato bicolore, effetto animalier.
Yarn-dyed jacquard fabric in a two-tone animal effect pattern.

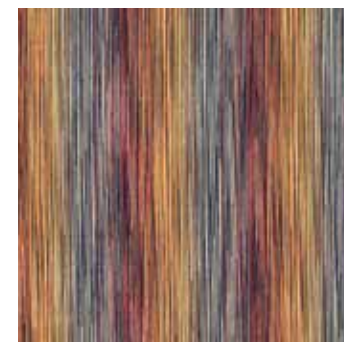

SANTIAGO

1S4Q022 - Col. 174
135 CM - 53 IN
89% VI - 11% PL

Velluto jacquard tinto filo, rigato.
Yarn-dyed velvet jacquard striped motif.

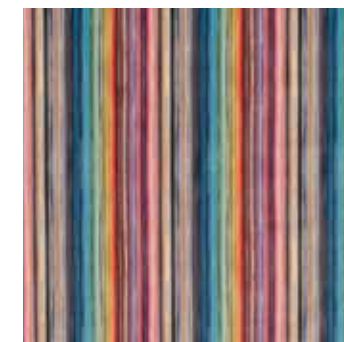

SIBERIA

1S4Q029 - Col. 100
135 CM - 53 IN
100% PL

Velluto stampato flame retardant, rigato effetto maglia.
Printed velvet jacquard flame retardant, striped knit effect.



SIBUYAN

1S4Q012 - Col. 156
135 CM - 53 IN
80% VI - 20% PL

Jacquard tinto filo, motivo chevron.
Yarn-dyed jacquard chevron motif.

INDOOR

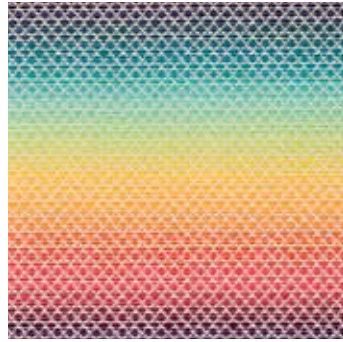

SIENA
1S4Q019 - Col. 100
 135 CM - 53 IN
 25% PA - 24% PC - 22% PL - 19% CO - 10% WO
 Jacquard tinto filo, multicolor sfumato.
Yarn-dyed jacquard shaded multicolor motif.



STANFORD
1S4Q018 - Col. 160
 140 CM - 55 IN
 60% PL - 40% PA
 Jacquard tinto filo, motivo chevron.
Yarn-dyed jacquard chevron motif.



STANFORD
1S4Q018 - Col. 172
 140 CM - 55 IN
 60% PL - 40% PA
 Jacquard tinto filo, motivo chevron.
Yarn-dyed jacquard chevron motif.



THAILAND
1T4Q008 - Col. 174 / 174R
 145 CM - 57 IN
 100% PL
 Jacquard double-face a motivo chevron fiammato.
Double-face jacquard fabric with a slub chevron design.



THONON
1F4Q176 - Col. T59
 140 CM - 55 IN
 46% CO - 33% PC - 17% LI - 4% VI
 Taffetà tinto filo, motivo maxi riga.
Yarn-dyed taffetà fabric striped motif.

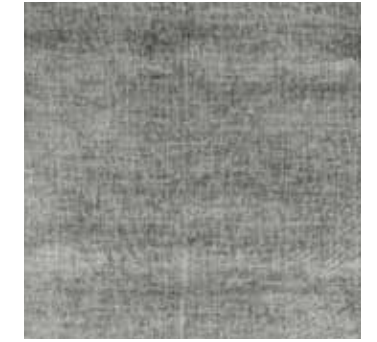

TIBET
1T4Q023 - Col. 32
 140 CM - 55 IN
 70% VI - 30% CO
 Velluto laserato di viscosa-cotone, effetto vintage.
Viscose and cotton laser-cut velvet, vintage effect.

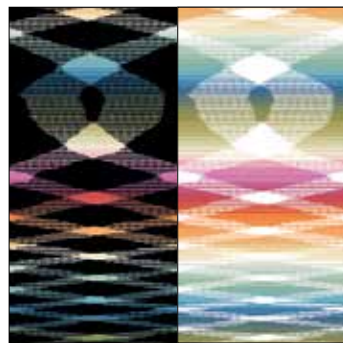

STOCCARDA
1S4Q024 - Col. 160 / 160R
 150 CM - 59 IN
 100% PL
 Jacquard tinto filo Trevira CS, motivo iconico fiammato multicolor double face.
Yarn-dyed reversible jacquard Trevira CS iconic multicolor slub motif.

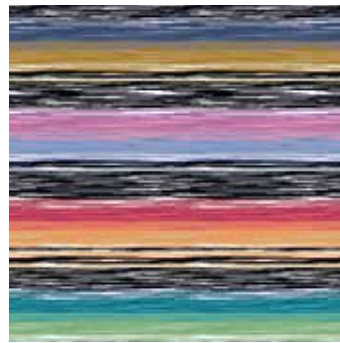

STRASBURGO
1S4Q023 - Col. 160
 150 CM - 59 IN
 100% PL
 Jacquard tinto filo Trevira CS, motivo iconico fiammato multicolor.
Yarn-dyed jacquard Trevira CS iconic multicolor slub motif.



SYDNEY
1H4RQ25 - Col. T59
 145 CM - 57 IN
 100% LI
 Panama stampato, motivo floreale.
Printed panama fabric giant floral motif.



TIBET
1T4Q023 - Col. 48
 140 CM - 55 IN
 70% VI - 30% CO
 Velluto laserato di viscosa-cotone, effetto vintage.
Viscose and cotton laser-cut velvet, vintage effect.



TIBET
1T4Q023 - Col. 74
 140 CM - 55 IN
 70% VI - 30% CO
 Velluto laserato di viscosa-cotone, effetto vintage.
Viscose and cotton laser-cut velvet, vintage effect.

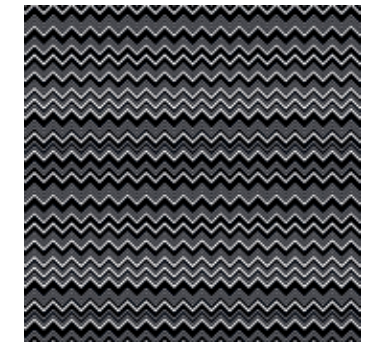

TOBAGO
1G4RC42 - Col. T20
 140 CM - 55 IN
 100% CO
 Reprs di cotone stampato a zigzag bianconeri.
Cotton rep with a black and white zigzag motif.

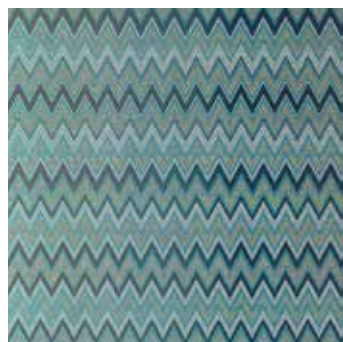

TAIPEI
1T4Q011 - Col. 164
 145 CM - 57 IN
 48% PL - 33% CO - 14% AC - 5% ME
 Jacquard chevron metallico degradé.
Shaded metallic chevron jacquard fabric.



TAIPEI
1T4Q011 - Col. 603
 145 CM - 57 IN
 48% PL - 33% CO - 14% AC - 5% ME
 Jacquard chevron metallico degradé.
Shaded metallic chevron jacquard fabric.



THAILAND
1T4Q008 - Col. 164 / 164R
 145 CM - 57 IN
 100% PL
 Jacquard double-face a motivo chevron fiammato.
Double-face jacquard fabric with a slub chevron design.



TOGO
1T4R003 - Col. 100
 135 CM - 53 IN
 63% CO - 37% LI
 Canva stampato, motivo chevron.
Printed canvas chevron motif.

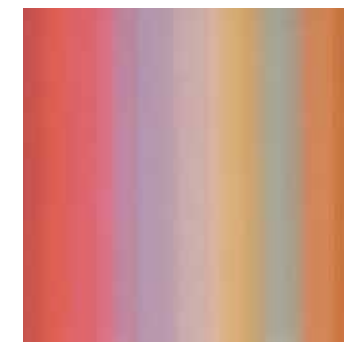

TOPEKA
1T4Q016 - Col. 100
 140 CM - 55 IN
 100% PL
 Jacquard tinto filo, motivo chevron sfumato.
Yarn-dyed jacquard shaded chevron motif.



TUNISI
1T4Q006 - Col. 100
 135 CM - 53 IN
 100% VI
 Velluto jacquard tinto filo, rigato.
Yarn-dyed velvet jacquard striped motif.

INDOOR



A.F

VANCOUVER

1V4R001 - Col. 100
135 CM - 53 IN
100% PL

Velluto stampato Trevira CS, motivo floreale.
Yarn-dyed printed velvet jacquard Trevira CS floral motif.



A.F

VANCOUVER

1V4R001 - Col. 160
135 CM - 53 IN
100% PL

Velluto stampato Trevira CS, motivo floreale.
Yarn-dyed printed velvet jacquard Trevira CS floral motif.



VANUATU

1V4Q014 - Col. 164
140 CM - 55 IN
100% VI

Velluto tinto in filo, motivo rigato.
Yarn-dyed velvet with striped design.

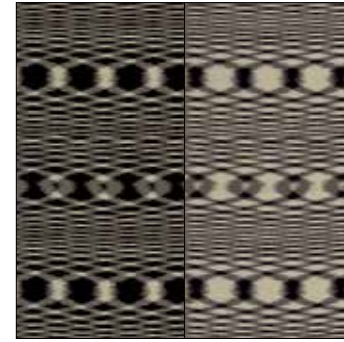

A.F

VILLASIMIUS

1V4Q025 - Col. 601 / 601R
150 CM - 59 IN
100% PL

Jacquard tinto filo Trevira CS, motivo iconico fiammato bitonale double face.
Yarn-dyed reversible jacquard Trevira CS iconic bi-tonal slub motif.



VINCI

1V4Q009 - Col. 100
145 CM - 57 IN
100% PL

Jacquard tinto filo con lurex, motivo chevron.
Yarn-dyed jacquard with lurex, chevron motif.

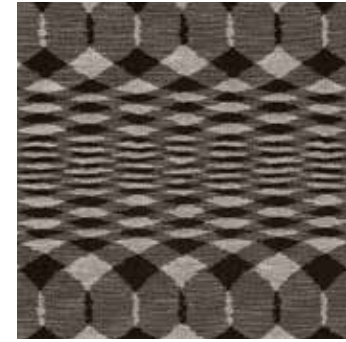

VISBY

1V4Q003 - Col. 601
140 CM - 55 IN
55% CO - 35% WO - 10% PA

Jacquard tinto filo, motivo iconico fiammato bitonale.
Yarn-dyed jacquard iconic bi-tonal slub motif.



VENICE

1V4R005 - Col. 100
140 CM - 55 IN
100% CO

Raso dama stampato, motivo farfalle.
Printed checkers satin with butterfly motif.



A.F

VERNAL

1V4Q019 - Col. 160 / 160R
150 CM - 59 IN
100% PL

Jacquard tinto filo Trevira CS, motivo chevron double face.
Yarn-dyed reversible jacquard Trevira CS chevron motif.



VEVEY

1F4RC37 - Col. T59
140 CM - 55 IN
100% CO

Reps di cotone stampato nell'iconico fiore-caleidoscopio.
Pure cotton rep with the unmistakable kaleidoscopic-flower print.



VITIM

1V4Q010 - Col. 164
105 CM - 41 IN
55% PL - 35% WO - 9% CO - 1% EA

Jacquard tinto filo, motivo chevron effetto tridimensionale.
Yarn-dyed jacquard 3D effect chevron motif.

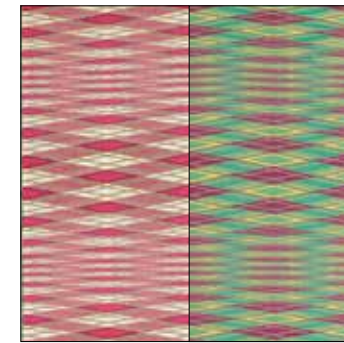

VULCANO

1V4Q016 - Col. 156 / 156R
145 CM - 57 IN
81% PL - 19% PC

Jacquard tinto filo, effetto maglia double face.
Yarn-dyed reversible jacquard knit effect.

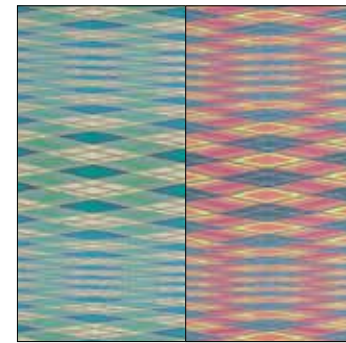

VULCANO

1V4Q016 - Col. 170 / 170R
145 CM - 57 IN
81% PL - 19% PC

Jacquard tinto filo, effetto maglia double face.
Yarn-dyed reversible jacquard knit effect.



VEVEY

1F4RC37 - Col. T60
140 CM - 55 IN
100% CO

Reps di cotone stampato nell'iconico fiore-caleidoscopio.
Pure cotton rep with the unmistakable kaleidoscopic-flower print.



VEVEY B&N

1J4RC57 - Col. 601
140 CM - 55 IN
100% CO

Reps di cotone stampato nell'iconico fiore-caleidoscopio.
Pure cotton rep with the unmistakable kaleidoscopic-flower print.

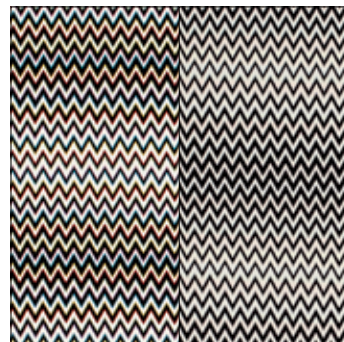

VIAREGGIO

1V4Q005 - Col. 160 / 160R
140 CM - 55 IN
74% CO - 26% VI

Jacquard tinto filo, motivo chevron double face.
Yarn-dyed reversible jacquard chevron motif.



WATERFORD

1W4Q006 - Col. 138
140 CM - 55 IN
51% VI - 49% PL

Jacquard a motivo chevron, effetto tridimensionale.
Jacquard fabric with 3D effect chevron design.



WATERLOO

1W4Q010 - Col. 164
135 CM - 53 IN
41% PL - 29% WO - 24% PC - 5% CO - 1% PA

Jacquard tinto filo, effetto tridimensionale.
Yarn-dyed jacquard 3d effect.



WEGGIS

1W4Q012 - Col. 174
135 CM - 53 IN
46% CO - 26% PL - 15% VI - 13% PA

Jacquard, fantasia foresta pittorica.
Jacquard fabric with pictorial woodland pattern.

INDOOR

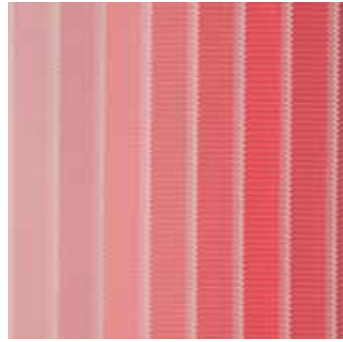

WELLS

1W4Q015 - Col. 156
145 CM - 57 IN
100% PL

Jacquard tinto filo, motivo chevron sfumato.
Yarn-dyed jacquard shaded effect chevron effect.

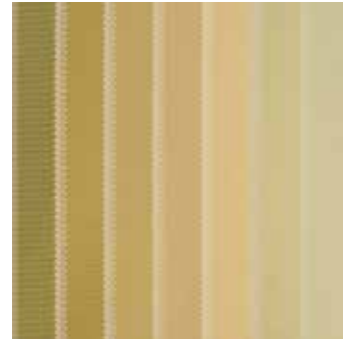

WELLS

1W4Q015 - Col. 162
145 CM - 57 IN
100% PL

Jacquard tinto filo, motivo chevron sfumato.
Yarn-dyed jacquard shaded effect chevron effect.

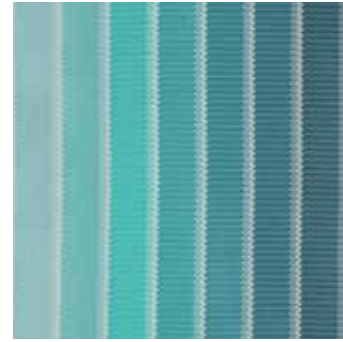

WELLS

1W4Q015 - Col. 174
145 CM - 57 IN
100% PL

Jacquard tinto filo, motivo chevron sfumato.
Yarn-dyed jacquard shaded effect chevron effect.

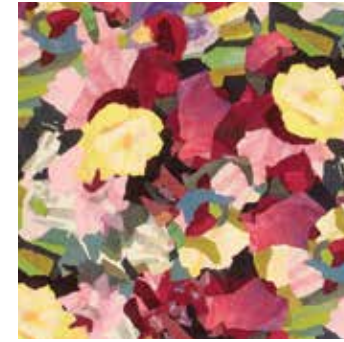

WIGHT

1W4R007 - Col. 100
140 CM - 55 IN
100% CO

Velluto di cotone stampato, motivo floreale.
Cotton printed velvet floral motif.



WILER

1W4Q017 - Col. 100
140 CM - 55 IN
100% PL

Jacquard tinto filo flame retardant, motivo rigato barrè.
Yarn-dyed flame retardant multicolor jacquard, striped barrè motif.



WINDSOR

1W4R006 - Col. 100
145 CM - 57 IN
100% PL

Jacquard stampato effetto corteccia, motivo floreale.
Printed jacquard bark effect, floral motif.

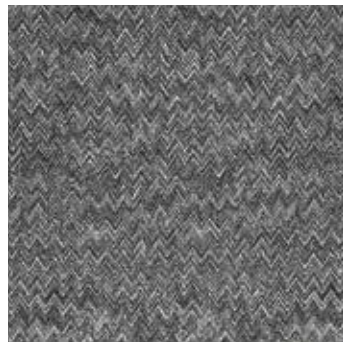

WELTENBURG

1W4Q020 - Col. 601
135 CM - 53 IN
40% VI - 20% PL - 15% LI - 15% WO - 10% CO

Jacquard tinto filo, motivo chevron bitonale.
Yarn-dyed jacquard, bi-tonal chevron motif.



WESTMEATH

1W4Q013 - Col. 138
140 CM - 55 IN
54% CO - 27% PL - 10% PC - 5% PM - 4% PA

Jacquard con lurex, motivo chevron.
Jacquard fabric with lurex, chevron motif.

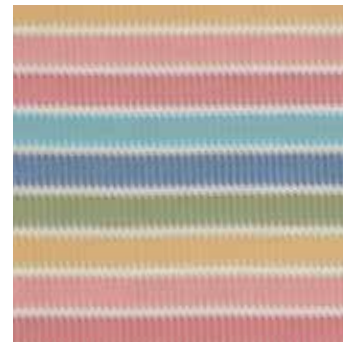

WESTMINSTER

1W4Q018 - Col. 100
140 CM - 55 IN
64% PL - 36% CO

Jacquard tinto filo, motivo chevron multicolor.
Yarn-dyed jacquard multicolor, chevron motif.



WINSLOW

1W4Q021 - Col. 160
150 CM - 59 IN
80% PL - 12% CO - 8% PC

Jacquard tinto filo, motivo geometrico patchwork.
Yarn-dyed jacquard, geometrical patchwork motif.



WINTERTHUR

1W4R004 - Col. 164
145 CM - 57 IN
100% CO

Raso di cotone, stampa fantasia di foresta.
Cotton satin with forest print.

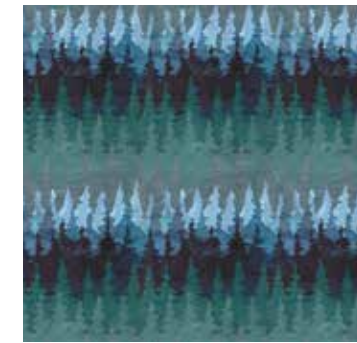

WINTERTHUR

1W4R004 - Col. 174
145 CM - 57 IN
100% CO

Raso di cotone, stampa fantasia di foresta.
Cotton satin with forest print.



WEYMOUTH

1W4Q016 - Col. 100
140 CM - 55 IN
100% PL

Jacquard tinto filo flame retardant, motivo chevron multicolor.
Yarn-dyed flame retardant multicolor jacquard, chevron motif.



WHITBY

1W4R003 - Col. 100
135 CM - 53 IN
63% CO - 37% LI

Canva stampato misto lino, motivo sfumato.
Printed linen blend canvas shaded motif.

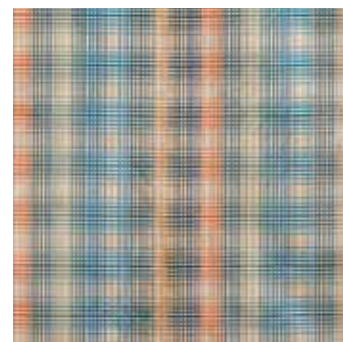

WHITTIER

1W4Q019 - Col. 148
140 CM - 55 IN
92% VI - 8% PL

Velluto jacquard tinto filo, geometrico.
Yarn-dyed velvet jacquard geometric motif.



WINTERTHUR

1W4R004 - Col. 186
145 CM - 57 IN
100% CO

Raso di cotone, stampa fantasia di foresta.
Cotton satin with forest print.

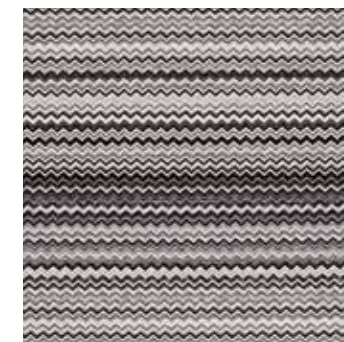

WIPITAL

1W4Q009 - Col. 601
140 CM - 55 IN
56% VI - 31% CO - 8% PC - 5% PL

Jacquard tinto filo, motivo chevron bitonale.
Yarn-dyed jacquard, bi-tonal chevron motif.



WISEN

1W4Q024 - Col. 22
140 CM - 55 IN
36% CO - 33% VI - 31% PL

Velluto jacquard tinto pezza, motivo chevron.
Piece dyed velvet jacquard, chevron motif.

INDOOR



WISEN

1W4Q024 - Col. 23

140 CM - 55 IN
36% CO - 33% VI - 31% PL

Velluto jacquard tinto pezza, motivo chevron.
Piece dyed velvet jacquard, chevron motif.



WISEN

1W4Q024 - Col. 28

140 CM - 55 IN
36% CO - 33% VI - 31% PL

Velluto jacquard tinto pezza, motivo chevron.
Piece dyed velvet jacquard, chevron motif.



WISEN

1W4Q024 - Col. 40

140 CM - 55 IN
36% CO - 33% VI - 31% PL

Velluto jacquard tinto pezza, motivo chevron.
Piece dyed velvet jacquard, chevron motif.



YAIZA

1Y4Q020 - Col. 21

135 CM - 53 IN
51% PC - 22% CO - 11% PL - 9% VI - 7% LI

Jacquard tinto filo bouclè, motivo chevron.
Yarn-dyed jacquard chevron bouclè motif.



YALATA

1Y4Q023 - Col. 156

130 CM - 51 IN
67% PL - 20% PC - 13% WO

Jacquard tinto filo con ciniglia, motivo chevron.
Yarn-dyed jacquard with chenille, chevron motif.



YAMAGATA

1Y4Q024 - Col. 100

140 CM - 55 IN
54% PL - 43% CO - 3% PM

Jacquard nei toni pastello, con lurex, motivo chevron.
Jacquard fabric in pastel tones with lurex detailing and chevron motif.



WISEN

1W4Q024 - Col. 48

140 CM - 55 IN
36% CO - 33% VI - 31% PL

Velluto jacquard tinto pezza, motivo chevron.
Piece dyed velvet jacquard, chevron motif.



WISEN

1W4Q024 - Col. 49

140 CM - 55 IN
36% CO - 33% VI - 31% PL

Velluto jacquard tinto pezza, motivo chevron.
Piece dyed velvet jacquard, chevron motif.



WISEN

1W4Q024 - Col. 61

140 CM - 55 IN
36% CO - 33% VI - 31% PL

Velluto jacquard tinto pezza, motivo chevron.
Piece dyed velvet jacquard, chevron motif.



YANAGAWA

1Y4Q008 - Col. 100

140 CM - 55 IN
60% PL - 26% CO - 14% VI

Jacquard tinto filo bouclè, motivo sfumato.
Yarn-dyed bouclè jacquard shaded motif.



YANAI

1Y4Q025 - Col. 100

150 CM - 59 IN
51% CO - 40% PL - 9% SE

Jacquard, nell'iconico chevron multicolore.
Jacquard fabric with iconic multicoloured chevron motif.



YASOTHON

1Y4Q022 - Col. 138

145 CM - 57 IN
53% VI - 27% CO - 20% PA

Jacquard tinto filo, motivo astratto.
Yarn-dyed jacquard abstract motif.



WISEN

1W4Q024 - Col. 65

140 CM - 55 IN
36% CO - 33% VI - 31% PL

Velluto jacquard tinto pezza, motivo chevron.
Piece dyed velvet jacquard, chevron motif.



WISEN

1W4Q024 - Col. 74

140 CM - 55 IN
36% CO - 33% VI - 31% PL

Velluto jacquard tinto pezza, motivo chevron.
Piece dyed velvet jacquard, chevron motif.



WOODSTOCK

1W4R005 - Col. 160

140 CM - 55 IN
100% CO

Velluto di cotone stampato, motivo geometrico patchwork.
Cotton printed velvet geometrical patchwork motif.



YASUJ

1Y4Q016 - Col. 148

140 CM - 55 IN
42% LI - 32% PL - 26% VI

Jacquard tinto filo, effetto maglia.
Yarn-dyed jacquard knit effect.

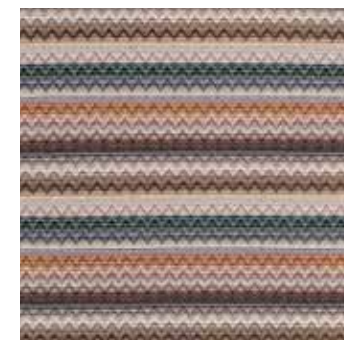

YATE

1Y4Q026 - Col. 164

140 CM - 55 IN
100% PL

Jacquard a chevron diluiti su sfondo sfumato.
Jacquard fabric with faded chevron motif against a blended background.

A.F ●



YELLABINNA

1Y4Q005 - Col. 603

140 CM - 55 IN
47% PC - 42% CO - 7% PA - 4% AC

Jacquard tinto filo con ciniglia.
Yarn-dyed jacquard with chenille.

INDOOR



YERRES

1Y4Q001 - Col. 164

145 CM - 57 IN
34% CO - 28% VI - 25% PL - 7% MD - 6% PA

Jacquard tinto in filo, motivo foresta pittorica.
Yarn-dyed jacquard pictorial forest motif.

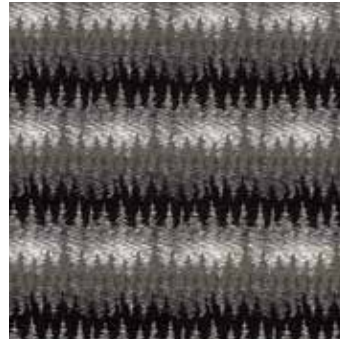

YERRES

1Y4Q001 - Col. 186

145 CM - 57 IN
34% CO - 28% VI - 25% PL - 7% MD - 6% PA

Jacquard tinto in filo, motivo foresta pittorica.
Yarn-dyed jacquard pictorial forest motif.



YLAN

1Y4Q006 - Col. 401

135 CM - 53 IN
42% PL - 33% CO - 12% VI - 11% LI - 2% PA

Jacquard tinto filo bouclé, motivo chevron.
Yarn-dyed jacquard chevron bouclé motif.



YZEURE

1Y4Q019 - Col. 164

130 CM - 51 IN
45% CO - 34% WO - 20% VI - 1% PA

Jacquard tinto filo bouclé, motivo chevron sfumato.
Yarn-dyed jacquard shaded chevron bouclé motif.

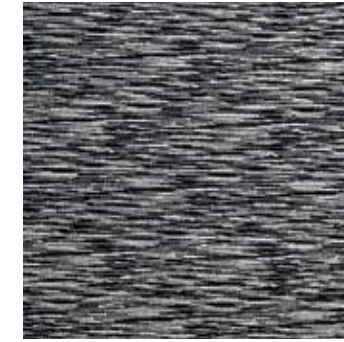

ZERMATT

1F4QC27 - Col. T60

140 CM - 55 IN
100% CO

Jacquard tinto filo, motivo iconico fiammato bitonale.
Yarn-dyed jacquard iconic bi-tonal slub motif.

INDOOR



YOKKAICHI

1Y4Q032 - Col. 100

135 CM - 53 IN
92% VI - 8% PL

Velluto jacquard tinto filo, rigato.
Yarn-dyed velvet jacquard striped motif.



YOKOHAMA

1Y4R003 - Col. 100

140 CM - 55 IN
100% LI

Puro lino, stampa motivo floreale.
Pure linen with floral print.



YUGAWARA

1Y4Q002 - Col. 100

140 CM - 55 IN
92% VI - 8% PL

Velluto di viscosa a micro quadretti multicolori, effetto arcobaleno.
Viscose velvet with multicoloured micro, check motif and rainbow effect.



YUJING

1Y4Q017 - Col. 601

140 CM - 55 IN
38% JU - 31% CO - 21% WO - 9% PC - 1% PA

Jacquard tinto filo, motivo losanghe in lana fil coupé.
Yarn-dyed jacquard lozenges fil coupé wool.



YUJING

1Y4Q017 - Col. 621

140 CM - 55 IN
38% JU - 31% CO - 21% WO - 9% PC - 1% PA

Jacquard tinto filo, motivo losanghe in lana fil coupé.
Yarn-dyed jacquard lozenges fil coupé wool.



YUZA

1Y4Q030 - Col. 100

145 CM - 57 IN
80% CO - 20% PL

Jacquard sfumato barré.
Jacquard fabric with blended stripe motif.

OUTDOOR



OUTDOOR



ALICANTE
1A4K003 - Col. 159
135 CM - 53 IN
100% PL

Tela stampata, motivo macro fiamme sfumate.
Printed canvas with shaded slub motif.



ANDALUSIA
1A4K004 - Col. 159
140 CM - 55 IN
100% PP

Jacquard tinto massa outdoor, motivo rigato barrè.
Solution-dyed outdoor jacquard striped barrè.



ATACAMA
1A4K001 - Col. 221
140 CM - 55 IN
100% PL

Tela stampata a motivo fiammato bitonale.
Printed canvas, with a bi-tonal slub motif.



BARCELONA NEW
1B4K005 - Col. 160
140 CM - 55 IN
94% PP - 6% PC

Tinto filo, motivo rigato barrè.
Yarn-dyed, striped barrè motif.



BATH NEW
1B4K006 - Col. 48 / 48R
145 CM - 57 IN
66% PP - 34% PC

Tinto filo, unito double face.
Yarn-dyed reversible plain fabric.

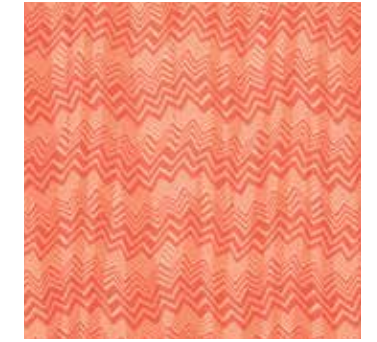

BELIZE NEW
1B4K002 - Col. 59
140 CM - 55 IN
100% PL

Canva stampata, motivo chevron.
Printed canvas, chevron motif.



ATACAMA
1A4K001 - Col. 591
140 CM - 55 IN
100% PL

Tela stampata a motivo fiammato bitonale.
Printed canvas, with a bi-tonal slub motif.



ATACAMA
1A4K001 - Col. 601
140 CM - 55 IN
100% PL

Canva stampata a motivo fiammato bitonale.
Printed canvas, with a bi-tonal slub motif.



ATACAMA
1A4K001 - Col. 621
140 CM - 55 IN
100% PL

Canva stampata a motivo fiammato bitonale.
Printed canvas, with a bi-tonal slub motif.



BELIZE NEW
1B4K002 - Col. 70
140 CM - 55 IN
100% PL

Canva stampata, motivo chevron.
Printed canvas, chevron motif.



BELMOPAN NEW
1B4K007 - Col. 100
145 CM - 57 IN
90% PP - 10% PC

Scozzese tinto filo.
Yarn-dyed tartan fabric.



BERKELEY NEW
1B4K012 - Col. 159
145 CM - 57 IN
100% PL

Jacquard tinto filo, motivo patchwork di punti maglia.
Yarn-dyed jacquard, knit patchwork effect.



ATACAMA
1A4K001 - Col. 721
140 CM - 55 IN
100% PL

Canva stampata a motivo fiammato bitonale.
Printed canvas, with a bi-tonal slub motif.

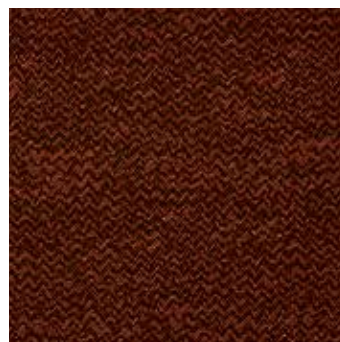

BALEARES NEW
1B4K010 - Col. 160
140 CM - 55 IN
100% PL

Jacquard tinto filo, motivo chevron.
Yarn-dyed jacquard, chevron motif.



BANGKOK NEW
1B4K013 - Col. 149
150 CM - 59 IN
75% PP - 25% PL

Jacquard tinto filo, motivo fiammato.
Yarn-dyed jacquard, slub motif.



BILBAO NEW
1B4K001 - Col. 160
145 CM - 57 IN
100% PC

Tessuto acrilico waterproof, a righe tinte in massa.
Mass dyed waterproof acrylic fabric, striped motif.



BODRUM NEW
1B4K008 - Col. 160
145 CM - 57 IN
62% PP - 38% PC

Tinto filo materico, rigato barrè.
Yarn-dyed material fabric, barrè striped motif.



BOGOTA NEW
1B4K003 - Col. 100
140 CM - 55 IN
100% PL

Canva stampata, motivo floreale.
Printed canvas, floral motif.

OUTDOOR



BOLIVIA NEW
1B4K009 - Col. 100
145 CM - 57 IN
90% PP - 10% PC

Tinto filo materico multicolor.
Yarn-dyed multicolor material fabric.



BONAMPAK NEW
1B4K011 - Col. 100
140 CM - 55 IN
100% PL

Jacquard tinto filo bouclè, motivo chevron sfumato.
Yarn-dyed bouclè jacquard shaded chevron motif.

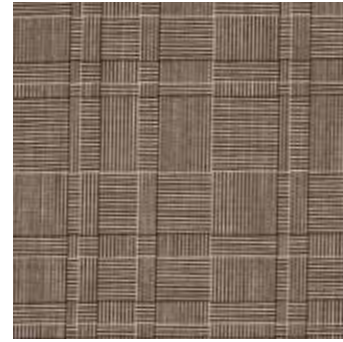

BRISTOL NEW
1B4K004 - Col. 601
145 CM - 57 IN
90% PP - 10% PC

Tinto filo materico, motivo geometrico bitonale.
Yarn-dyed material fabric, bi-tonal geometrical motif.



KEW MTC
104K009 - Col. 170
130 CM - 51 IN
100% PL

Tessuto tecnico outdoor, stampa digitale a macro chevron multicolori.
High-tech outdoor fabric with a multicoloured chevron digital print.



RAINBOW B&N
1H4RE06 - Col. T20
150 CM - 59 IN
100% PC

Tessuto tecnico outdoor, stampato a righe alternate.
High-tech outdoor fabric, printed with alternating stripes.

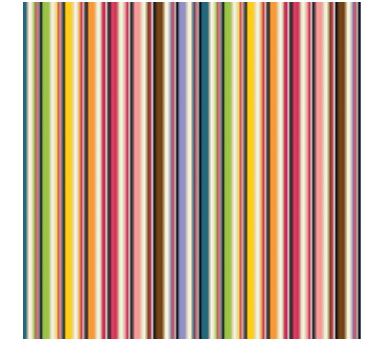

RAINBOW MTC
1H4RE03 - Col. T16
150 CM - 59 IN
100% PC

Tessuto tecnico outdoor, stampato a righe multicolori alternate.
High-tech outdoor fabric, printed with alternating multicolored stripes.



DALIA BN
104K011 - Col. 601
135 CM - 53 IN
100% PC

Tessuto tecnico per outdoor, tinto in massa e stampato a macro dalie.
High-tech outdoor fabric with macro dahlia print.

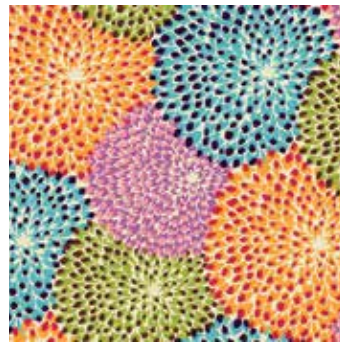

DALIA MTC
104K010 - Col. 159
135 CM - 53 IN
100% PC

Tessuto tecnico per outdoor, tinto in massa e stampato a macro dalie multicolori.
High-tech outdoor fabric with multicolour macro dahlia print.

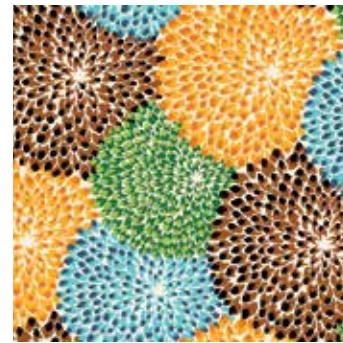

DALIA MTC
104K010 - Col. 160
135 CM - 53 IN
100% PC

Tessuto tecnico per outdoor, tinto in massa e stampato a macro dalie multicolori.
High-tech outdoor fabric with multicolour macro dahlia print.

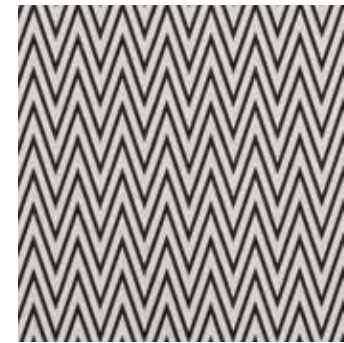

RIVAS
1R4K006 - Col. 601
140 CM - 55 IN
100% PL

Jacquard tinto filo outdoor, motivo chevron.
Yarn-dyed outdoor jacquard chevron motif.



SAL
1S4K004 - Col. 48
145 CM - 57 IN
100% PC

Canva tinto massa outdoor unito.
Solution-dyed outdoor plain canvas fabric.

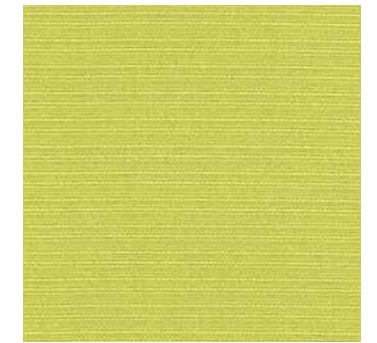

SAL
1S4K004 - Col. 53
145 CM - 57 IN
100% PC

Canva tinto massa outdoor unito.
Solution-dyed outdoor plain canvas fabric.



KEW BN
104K012 - Col. 601
130 CM - 51 IN
100% PL

Tessuto tecnico outdoor, stampa digitale a macro chevron.
High-tech outdoor fabric with a chevron digital print.



KEW MTC
104K009 - Col. 100
130 CM - 51 IN
100% PL

Tessuto tecnico outdoor, stampa digitale a macro chevron multicolori.
High-tech outdoor fabric with a multicoloured chevron digital print.



KEW MTC
104K009 - Col. 159
130 CM - 51 IN
100% PL

Tessuto tecnico outdoor, stampa digitale a macro chevron multicolori.
High-tech outdoor fabric with a multicoloured chevron digital print.



SAL
1S4K004 - Col. 59
145 CM - 57 IN
100% PC

Canva tinto massa outdoor unito.
Solution-dyed outdoor plain canvas fabric.

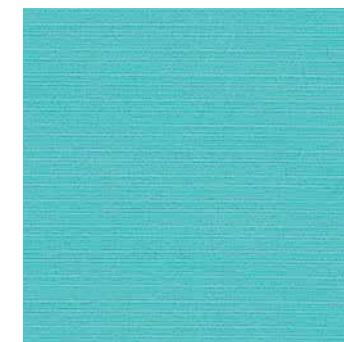

SAL
1S4K004 - Col. 70
145 CM - 57 IN
100% PC

Canva tinto massa outdoor unito.
Solution-dyed outdoor plain canvas fabric.

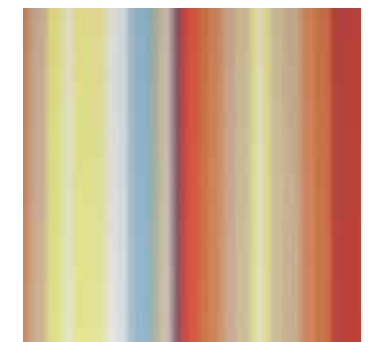

TONGA
1T4K003 - Col. 159
150 CM - 59 IN
100% PC

Tessuto acrilico waterproof, a righe sfumate tinte in massa.
Waterproof fabric with mass-dyed shaded stripes. Also suitable for outdoor use.

OUTDOOR

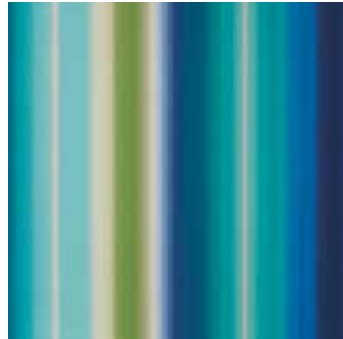

TONGA
1T4K003 - Col. 170
150 CM - 59 IN
100% PC

Tessuto acrilico waterproof, a righe sfumate tinte in massa.
Waterproof fabric with mass-dyed shaded stripes. Also suitable for outdoor use.



TUPAI
1T4K004 - Col. 211
140 CM - 55 IN
100% PP

Jacquard tinto filo outdoor, motivo geometrico bitonale.
Yarn-dyed outdoor jacquard bi-tonal geometrical motif.



TUPAI
1T4K004 - Col. 531
140 CM - 55 IN
100% PP

Jacquard tinto filo outdoor, motivo geometrico bitonale.
Yarn-dyed outdoor jacquard bi-tonal geometrical motif.



WALLIS
1W4K002 - Col. 160
135 CM - 53 IN
100% PL

Panama stampa digitale motivo passiflora.
Panama fabric with passion flower print.



WASIRI
1W4K005 - Col. 21
145 CM - 57 IN
100% PP

Jacquard tinto massa outdoor, motivo geometrico.
Solution-dyed outdoor jacquard geometric motif.



WAYA
1W4K009 - Col. 100
140 CM - 55 IN
100% PL

Canva stampato outdoor, motivo floreale.
Printed cotton canvas outdoor fabric with floral motif.



TUPAI
1T4K004 - Col. 601
140 CM - 55 IN
100% PP

Jacquard tinto filo outdoor, motivo geometrico bitonale.
Yarn-dyed outdoor jacquard bi-tonal geometrical motif.



TUPAI
1T4K004 - Col. 701
140 CM - 55 IN
100% PP

Jacquard tinto filo outdoor, motivo geometrico bitonale.
Yarn-dyed outdoor jacquard bi-tonal geometrical motif.



VARADERO
1V4K004 - Col. 31
140 CM - 55 IN
100% PP

Jacquard tinto filo outdoor, motivo chevron.
Yarn-dyed outdoor jacquard chevron motif.

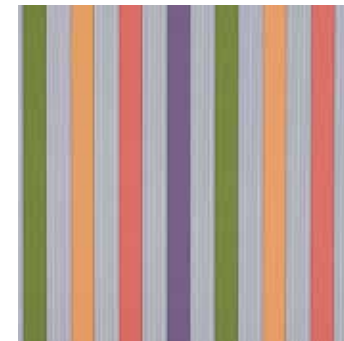

WELKOM
1W4K001 - Col. 100
145 CM - 57 IN
100% PC

Tessuto outdoor tinto in massa, motivo rigato.
Solution-dyed outdoor fabric striped motif.



WIEN
1W4K007 - Col. 100
145 CM - 57 IN
100% PP

Jacquard tinto massa outdoor, motivo geometrico.
Solution-dyed outdoor jacquard geometric motif.

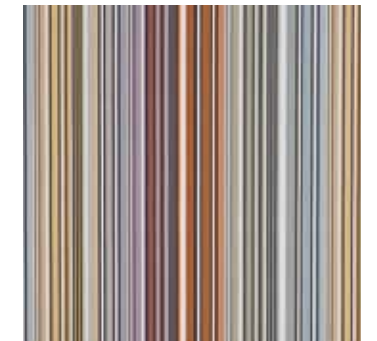

WINDHOEK
1W4K003 - Col. 160
150 CM - 59 IN
100% PC

Tessuto outdoor tinto in massa, a micro righe multicolori.
Solution-dyed outdoor fabric with multicoloured micro stripes.



VARADERO
1V4K004 - Col. 61
140 CM - 55 IN
100% PP

Jacquard tinto filo outdoor, motivo chevron.
Yarn-dyed outdoor jacquard chevron motif.



VILLAHERMOSA
1V4K003 - Col. 100
135 CM - 53 IN
100% PL

Panama stampa digitale outdoor, motivo farfalle.
Digital printed outdoor panama fabric butterfly motif.



WAHAI
1W4K004 - Col. 21
145 CM - 57 IN
100% PP

Jacquard tinto massa outdoor, motivo floreale.
Solution-dyed outdoor jacquard floral motif.

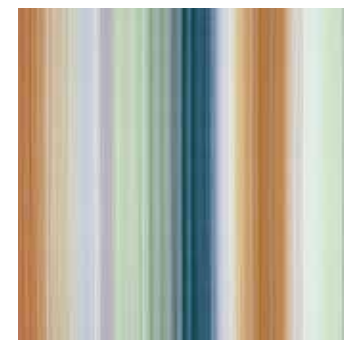

WONGA
1W4K010 - Col. 100
150 CM - 59 IN
100% PC

Tessuto outdoor tinto in massa, motivo rigato sfumato.
Solution-dyed outdoor fabric shaded striped motif.



YACILA
1Y4K002 - Col. 701
145 CM - 57 IN
100% PP

Jacquard tinto massa outdoor, motivo astratto floreale.
Solution-dyed outdoor jacquard fabric with abstract floral motif.

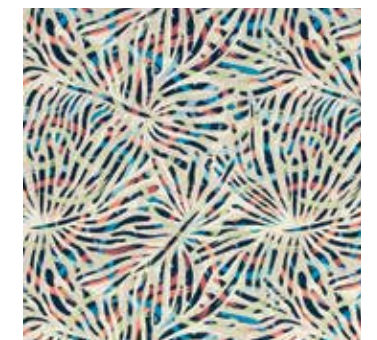

YACUIBA
1Y4K003 - Col. 100
140 CM - 55 IN
100% PL

Canva stampato outdoor, motivo astratto floreale.
Printed cotton canvas outdoor jacquard fabric with abstract floral motif.

OUTDOOR

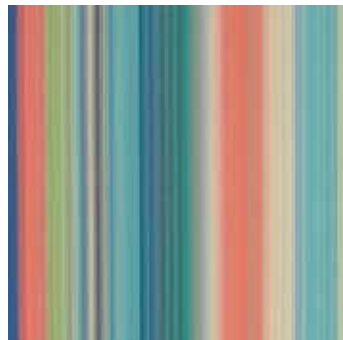

YUMBEL

1Y4K001 - Col. 100

145 CM - 57 IN

100% PC

Tessuto tecnico outdoor, a sequenze di micro righe.

High-tech outdoor fabric with micro-stripe motif.

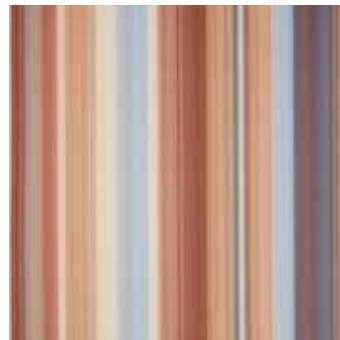

YUMBEL

1Y4K001 - Col. 160

145 CM - 57 IN

100% PC

Tessuto tecnico outdoor, a sequenze di micro righe.

High-tech outdoor fabric with micro-stripe motif.

SHEERS



SHEERS

**BELLEVILLE NEW****1B4T002 - Col. 159**150 CM - 59 IN
43% WO - 16% CO - 15% AC - 15% PL - 11% SE

Jacquard tinto filo, effetto maglia.

Yarn-dyed jacquard, knit effect.**BOA VISTA NEW****1B4TW01 - Col. 140**145x300 CM - 57x118 IN
100% VI

Tenda a frange.

Fringed sheer.**BOURGOGNE NEW****1B4T001 - Col. 48**325 CM - 127 IN
100% LI

Jacquard tinto filo in lino, motivo chevron tono su tono.

Yarn-dyed linen jacquard, ton sur ton chevron motif.**TAJMYR****1T4T001 - Col. 164**300 CM - 118 IN
95%LI - 5%PL

Tenda jacquard tinto filo, motivo rigato.

Yarn-dyed jacquard sheer striped motif.**TANZANIA****1T4T008 - Col. 100**330 CM - 130 IN
100% PL

Tenda jacquard tinto filo Trevira CS, motivo rigato.

Yarn-dyed jacquard sheer Trevira CS striped motif.**TOKELAU****1T4T005 - Col. 48**330 CM - 130 IN
86% PC - 14% PL

Tenda jacquard tinto massa outdoor Trevira CS, motivo sfumato.

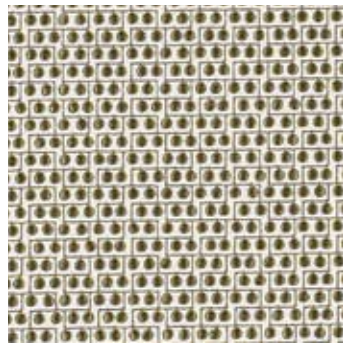
Solution dyed outdoor jacquard sheer Trevira CS shaded motif.**JAMILENA****1J4QU46 - Col. 40**140 CM - 55 IN
100% PL

Tenda in tulle ricamato.

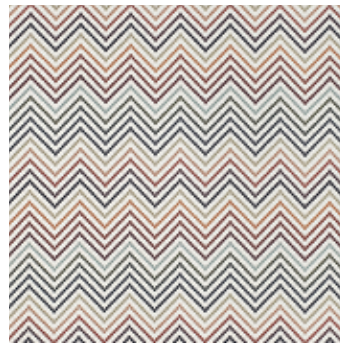
Emboidered tulle sheer.**KEA****1K4QU52 - Col. 156**140 CM - 55 IN
100% PL

Tenda in tulle ricamato, motivo chevron effetto tridimensionale.

Emboidered tulle sheer with 3D effect chevron motif.**KINGSTON****1K4TW17 - Col. 31**150x300 CM - 59x118 IN
100% VI

Tenda a frange lamè.

Viscose sheer with lamè fringes.**TOKELAU****1T4T005 - Col. 70**330 CM - 130 IN
86% PC - 14% PL

Tenda jacquard tinto massa outdoor Trevira CS, motivo sfumato.

Solution dyed outdoor jacquard sheer Trevira CS shaded motif.**VASTO****1V4TW03 - Col. 160**145x300 CM - 57x118 IN
100% PL

Tenda a frange flame retardant.

Viscose flame retardsnt sheer with lamè fringes.

A.F ●

**WACO****1W4T005 - Col. 100**300 CM - 118 IN
100% PL

Tenda a garza stampata, motivo geometrico patchwork.

Printed gauze sheer geometrical patchwork motif.**KINGSTON****1K4TW17 - Col. 40**150x300 CM - 59x118 IN
100% VI

Tenda a frange lamè.

Viscose sheer with lamè fringes.**NOJA****1N4T005 - Col. 159**150 CM - 59 IN
100% PL

Tenda jacquard tinto filo, motivo chevron sfumato.

Yarn-dyed jacquard sheer shaded chevron.**PEQUI****1P4T001 - Col. 21**290 CM - 114 IN
65% PL - 35% VI

Tenda in tulle ricamato, motivo chevron.

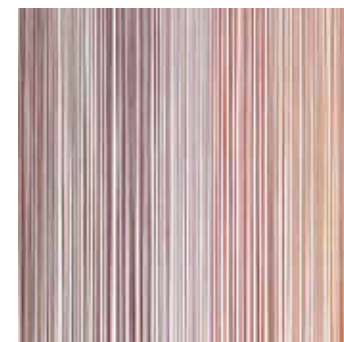
Emboidered tulle sheer with chevron motif.**WORCESTER****1W4TW01 - Col. 156**145x300 CM - 57x118 IN
100% PL

Tenda a frange flame retardant.

Viscose flame retardsnt sheer with lamè fringes.

A.F ●

**WORCESTER****1W4TW01 - Col. 174**145x300 CM - 57x118 IN
100% PL

Tenda a frange flame retardant.

Viscose flame retardsnt sheer with lamè fringes.

A.F ●

**YAMADA****1Y4T003 - Col. 100**300 CM - 118 IN
51% LI - 49% CO

Tenda jacquard tinto filo, motivo sfumato.

Yarn-dyed jacquard sheer shaded motif.

